

04/06/2020

VISUAL GAME AND MEDIA DESIGN MASTER PROGRAMME
KADK THE ROYAL DANISH ACADEMY OF FINE ARTS,
SCHOOLS OF ARCHITECTURE, DESIGN AND CONSERVATION

Master Project Report

Spring 2020

ALEXIS EMMANUEL LOZANO ANGULO

allo1834@edu.kadk.dk / aelozanoa@gmail.com

Supervisor: **ALESSANDRO CANOSSA**

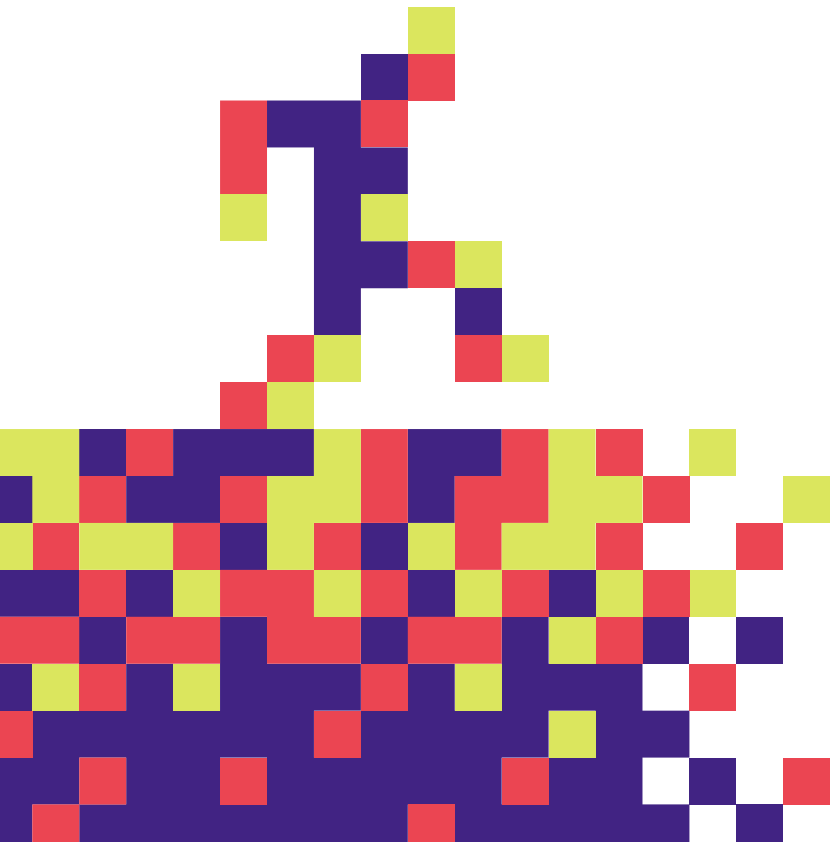



Index

02	Index	23	9. Future implementations
03	Acknowledgements	24	10. Learnings
04	Game link	25	11. Conclusion
05	Initial notes	27	12. Appendix
05	Abstract	131	Credits and resources
05	Introduction	132	Game theory and practice references
06	1. Problem and context	133	Sustainability and food systems references
08	2. Project description		
09	3. Methods, frameworks, design tools, and theory		
13	4. Game state of the art		
15	5. Process		
19	6. Playtests		
21	7. SUBSYST Simulator		
22	8. Assessment		



Acknowledgements

I would like to thank my supervisor, Alessandro Canossa, PhD, for his guidance throughout the different stages of this project. I would like to thank Jesper Juul, PhD, for providing a reference to the Transformational Framework, which guided the structure of this project. I would like to thank Lykke Bloch Kjær, MLAICS, for providing references about sustainability, which was elemental for the project's content.

I would like to acknowledge Christian Laumark Hansen, MA, Sabrina Haskell Culyba, MET, and Thomas Vigild, MSc, for sharing their valuable feedback, which nurtured the project. I would like to acknowledge Michael R. Schmidt, MSc, for his technical support and advice for the programming stage of the project.

I would like to thank my colleagues Shalev Moran, Viktor Henderson, Laurent Gehin, Bjørn Helstrup Sørensen, and Bjørn Højlund Rasmussen for the meaningful conversations we held, which nurtured the project.

I would like to thank the participants of the assessment tests Diana Alvarez, Héctor Alonso, Claudia Flores, Isak Salomon Køster, Carlo Flores, Joakim Carlsen, Mette Nonboe Frederiksen, and other testers for their patience and feedback, which was essential for the project.

I would like to thank my family and friends, who have supported me along this intense semester and throughout my master studies. I especially thank Ventura Isabel Angulo Pimentel and Humberto Lozano Hernández, for their support and love, as well as Paulo Humberto Lozano Angulo and José Arturo Lozano Angulo for testing the game.

To all the people who supported my work and process in this project, thank you.

The game

It is possible to play the project's game in a PC or Mac web-browser, on itch.io.

LINK

<https://eplundare.itch.io/subsyst-simulator>



Initial notes

Adapting the project THE CORONAVIRUS CONTEXT

The project's game is designed with the intention of increasing the knowledge of players. Therefore, an assessment process was considered, in order to measure the effectiveness of the game. However, due to the COVID-19 pandemic, this process could not be executed as planned.

An ideal scenario would have been to interview citizens in the public space and invite those who fitted the target audience profile to play the project's game. Nonetheless, the assessment playtests took place through digital means with other players.

It is worth mentioning that the user research phase took place in the public space, a month before the social distancing measures started in Copenhagen.

Changes to the Program

The program detailing the project's plan was submitted on the 6th of February of 2020.

In that moment, the objective of the project was to design a mobile game. However, this goal shifted into a web-browser game.

Several game references also changed. This report includes some of those examples, and elaborates on other games and genres which served as inspiration for the project's game design.

Abstract

This report presents the research, frameworks, process and results of developing an incremental game, the *SUBSYST Simulator*, where players sustain a region through a circular system of food, energy, and waste management. The project's objective is to increase the knowledge of players regarding food systems, responsible consumption, and circular economy for food. The work presented is set within the context of Goals 11, 12, and 13 of the UN Sustainable Development Goals. Strategy games, incremental games and other genres, as well as the concept of discomfort, were used as references to design the game's mechanics.

An assessment plan was applied to demonstrate the transformational impact of the game.

Introduction

The *SUBSYST Simulator* is a single-player game, with incremental clicking mechanics where the player will face the challenges of producing food while maintaining the natural and social well-being. In the game, it is possible to produce different products, like chicken or algae, at small-scale or industrial levels. The game's economy system is built upon the relationships of food production, energy resources and waste management.



The game. Players can produce food and energy. They can also manage waste. The goal is to sustain the social and natural well-being of the region.

The game recognises the role of players in society. *SUBSYST* invites them to reflect about the carbon footprint of different products, the relationships in food systems, and the positive impact that responsible consumption may have on the environment. The game is circumscribed within the context of the UN Sustainable Development Goals. The intention of the project is to generate positive transformations in players. Therefore, this report elaborates on how the game was designed to achieve this goal and deploy its meaning.

The report is structured in three main sections. The first one elaborates on the context, project description, methodology, theoretical background, user research, and game design of the project. The second section comprises the design process, playtests, results and assessment of the game's transformational effectiveness. The closing section describes the learnings obtained throughout the project.

1. Problem and context

UN Sustainable Development Goals

The *SUBSYST* project is encompassed within Goals 11, 12, and 13 of the United Nations Sustainable Development Goals: Sustainable cities and communities, Responsible consumption and production, and Climate Action, respectively. The project proposes to reflect on some of the ways in which societies produce and consume food, as well as how they process food by-products.

It does this by contrasting sustainable and unsustainable practices. This comparison is based on information published by the Ellen MacArthur Foundation, an international organization building a network for regenerative economies.

It was important to have a general understanding about sustainability, the food production carbon footprint, food systems, and responsible consumption. For this reason, it was essential to use documentation from subject-matter experts, like the Food and Agriculture Organization of the United Nations (FAO) and the United Nations One Planet network.

Sustainability and sustainable development

Sustainability relates to “finding some sort of steady state so that Earth (...) can support the human population and economic growth without ultimately threatening the health of humans, animals, and plants”. Therefore, sustainability also takes in consideration the impacts of humans on the health of the Earth and its ability to support human populations (**Portney, 2013**).

Food waste and food production carbon footprint

Economic growth, societies and the environment are linked together. It is a complex relationship, which may result in wasted resources and greenhouse gas (GHG) emissions. The FAO states that approximately one-third of all food produced for human consumption

in the world is lost or wasted every year. “The carbon footprint of food produced and not eaten is estimated to [be] 3.3 Gtonnes of CO2 equivalent: as such, food wastage ranks as the third top emitter after [the] USA and China.” (FAO, 2013).

Besides the GHG emissions from wastage, the production of food has an impact on the environment. Its processing, transportation, and waste disposal are some of the factors influencing a product’s carbon footprint. “For example, vegetable production in Europe is more carbon intensive than vegetable production in Industrialized and Southeast Asia, as Europe uses more carbon intensive means of production, such as artificially heated greenhouses” (FAO, 2013).

Circular economy for food

In 2013, the global food expenditure was USD 6.71 trillion. Summed to these, linear food systems involve costs which could be prevented. For every USD 1 spent on food, USD 2 are incurred in economic, health, and environmental costs, such as malnutrition, farming soil degradation, and reduced soil water retention, amongst other effects. (Ellen MacArthur Foundation, 2019).

There is unused potential in waste, since less than two percent of the valuable nutrients from discarded organic resources gets looped back to productive use. Circular economy systems offer an alternative to linear models, by designing out waste and pollution, keeping products and materials in use, and regenerating natural systems (Ellen MacArthur Foundation, 2019).

Food systems

Food systems are complex and involve heavily interlinked elements which the UN’s One Planet network denominates as drivers, activities and outcomes. These activities consist of different stages, from growing and harvesting to consumption and disposal. These involve a wide range of actors, such as food producers, food brands,



Circular economy for food. Relationship between food, cities, and by-products. Source: Ellen MacArthur Foundation, 2019. Cities and Circular Economy for Food.

retailers, food buyers and traders, restaurants, waste management companies, governments, as well as learning and financial institutions (Lomax, Bortoletti and UN-Environment, 2019).

The Collaborative Framework for Food Systems Transformation underlines the importance of collaboration between different agents in society. The participation of governments, producers, and consumers is essential within the intricacies of food systems (Lomax, Bortoletti and UN-Environment, 2019). Even though a great proportion of the changes in food systems pertain to governments and production processes, the joint effort of consumers will be important for the adoption of new practices and policies in society.

Psychological barriers

Besides the environmental aspects of climate change and food systems, there's a psychological dimension to climate science communications. Per Espen Stoknes, psychologist with a PhD in economics, elaborates about five psychological barriers between people and media: Distance, doom, dissonance, denial and identity. As Stoknes explains, "Any story that tells me that my identity and lifestyle are wrong and destructive will be subconsciously resisted." (Stoknes, 2015).

On the other hand, he explains that "stories of economic revitalization (...), happiness, social justice and the good life (vision), stewardship (aligning ourselves with higher values), and re-wilding [sic] (teaming up with the self-healing forces in nature) all offer us a way around the most deeply seated barriers in the minds (...) of modern citizens" (Stoknes, 2015).



Revitalization stories. The principles of circular economy propose alternatives to linear economic models. Source: Ellen MacArthur Foundation, 2019. Cities and Circular Economy for Food.

2. Project description

Higher purpose

This project was led by the purpose of developing sustainable societies and food systems, by reducing the carbon footprint of food production and consumption, and waste.

SUBSYST contributes to this purpose by enabling a space where players can control a food economy, while managing the environmental impact of their decisions in a virtual region. The game simulates the dynamics of non-regenerative industrial models and sustainable-circular economies for food; hence the pillar of the game is conformed by the management of food production and its by-products.

Research question

In this context, the project was developed around the following research question: Is it possible to intentionally elicit knowledge transformations in players with a simulation incremental game?

Design intention

The project parts from the perspective of seeing players as agents in society. Hence, the design of the game has been focused on developing one main transformation. It consists of increasing the player's knowledge regarding the resources and challenges present in food systems. The game explores how the affordances of simulation and incremental mechanics can deploy this value.

Game design objective and aesthetic experience

The game design objective seeks to evoke the experience of confronting the cost-benefit challenges of both linear and circular economy for food models. The game was designed to visualize the relationships in food systems and their implications in social and natural environments.

The simulation uses the barrier of doom, described by Stoknes, as a tool to convey two messages. The first message conveys an idea of prosperity, where environmental and social wellbeing can be nurtured through sustainable



Actors in food systems. Several actors impact how food systems work. Icons retrieved from Ellen MacArthur Foundation, 2019. *Cities and Circular Economy for Food*.

development. The second message portrays social and natural decay when player decisions bolster industrial infrastructure and accelerated food production. The game also presents the questions about what are the possible challenges of both development models and whether it is possible to achieve a balanced state between these two systems.

**Target audience
persona**

The target player of the game is based on a three-level persona: the player-person, the player-interpreter, and the player-player. These levels are based on the Triadic Game Design worlds (**Harteveld, 2011**).

As player-person, the target group consists of women or men, between 30 to 45 years old. They are socially active. They like to spend time with friends in easygoing gatherings. They are either married or live together with their partner.

As interpreters, they consume news on a regular basis and have basic to medium notions about sustainable practices or habits. They are attentive and sensitive to global events, especially those regarding political and warfare conflicts, as well as the relationships between world powers and their home country.

As players, they have previous experiences with board games and video games. They enjoy strategy games, such as *Risk* and quiz games, like *Trivial Pursuit*. They have played competitive and party video games, i.e. *Mario Kart* games. They may also play fitness video games, such as *Ringfit Adventure* for the Nintendo Switch.

**My role in
the project**

SUBSYST was developed as a solo project. My roles and tasks involved user research, game design and prototyping, as well as UI and graphic design, animations and art direction.

The current 3d models used in the game are from the Polygon Game Dev Humble Bundle, by Synty Studios. Michael R. Schmidt provided technical support related to the tech-art (outline for 3d objects and color blending system) and programming (game economy system). The outline shader was downloaded from Erik Roystan Ross's website. Most animations in the game are handled using the LeanTween library. The camera mouse-drag and other UI functionalities were scripted based on code from different Unity Forums and Unity Answers users. The credits to the music, sound effects and the other elements mentioned in this paragraph appear in the "**Credits and resources**" section.

3. Methods, frameworks, design tools, and theory

The research and pre-production stages were developed using the Transformational Framework by Sabrina Culyba and the Triadic Game Design by Casper Harteveld, both as complementary guidelines for the project. A series of interviews and the Zaltman Metaphor Elicitation Technique (ZMET) were also used during these stages.

An iterative design process was used during the pre-production and production stages. The use of Grow a Game cards guided the exploration of gameplay mechanics and themes. Cards from A Deck of Lenses, by Jesse Schell later guided decisions to improve the mechanics of the game. Afterwards, Machinations, an online game design tool, as well as a series of playtests were used to balance the economy system of the game. Further details about Machinations are described in the “**Process**” section.

The impact of SUBSYST was later tested using questionnaires and playtests during the assessment stage. This will be discussed in the “**Assessment**” section.

The concept of discomfort and some elements of dark game design patterns were used as rhetoric tools. At the end of this section, these elements are discussed.

Frameworks

Transformational Framework

The Transformational Framework can be used as a holistic tool. It has been used by Schell Games to understand the complexities of a game intended to generate a change in players. It has been employed with games like *Happy Atoms*, designed to “demystify chemistry by giving players a hands-on way to explore the structure of molecules and their applications”, or *PlayForward: Elm City Stories*, which “aims to reduce HIV exposure in at-risk teens by changing their skills, knowledge, and behaviors around risky situations” (Culyba, 2018).

The framework focuses on eight criteria: the higher purpose of the project, the audience and its context, player transformations, the barriers preventing such transformations, the domain or subject-matter, expert

resources, prior works and the assessment of the transformations (Culyba, 2018). These aspects are discussed throughout different sections in this report. **The “Transformational summary” consecutively presents these criteria in the appendix (p.36).**

The project’s higher purpose can be related to several agents in society, such as food producers, retailers and consumers, among others. It is unlikely that *SUBSYST* can directly affect all of these social and economic actors. Therefore, it is worth acknowledging that the scope of the game is directed towards consumers.

Culyba elaborated on the Three Hallmarks of a Transformational Game consisting of intention, transfer, and persistence (Culyba, 2018). In this sense, *SUBSYST* was designed with the intention of increasing the player’s knowledge about food systems and responsible consumption. To deploy this transformation, the game visualizes

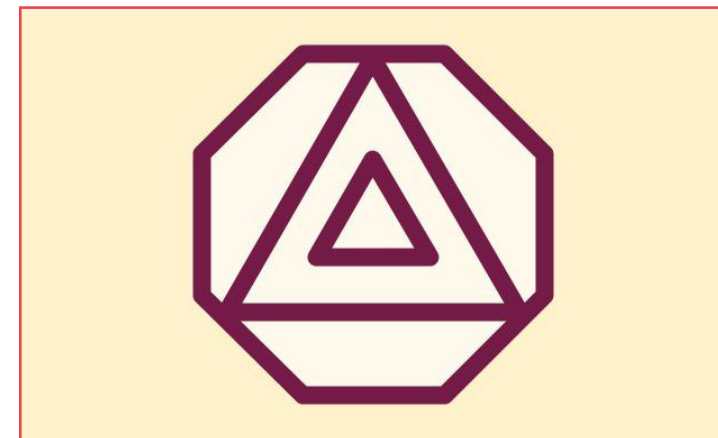

Multi-framework approach. The eight criteria of the Transformational Framework and the Triadic Game Design worlds set the structure of the project.



Model of reality. The game portrays the relationships between food production, energy production, and waste management.

the relationships of food production, consumption and waste management. The value of the game persists if the intended transformations happen and remain after the gaming session. An assessment stage was used to analyze the impact of the game. The results of this evaluation are discussed in the **“Assessment”** section.

Triadic Game Design

In a parallel perspective, the Triadic Game Design considers three worlds: reality, meaning and play. The world of reality relates to the domain concepts and subjects addressed in the game. The world of meaning refers to the value and messages deployed by the game. Finally, the world of play refers to the affordances of the game’s genre and gameplay mechanics. This framework has been used to analyze *Levee Patroller*, a game which teaches about levee or dam failures in Holland, as well as *September 12th*, which uses its gameplay mechanics to

portray the vicious circle between missile attacks from a military power on a desert-like city, subsequently killing civilians and engendering terrorism (**Harteveld, 2011**).

This triadic framework was used to coherently design *SUBSYST*. In this case, the world of reality comprehends the domain of circular economy for food. This subject-matter was abstracted into a model of reality. The pillars of this model are the relationships between food, energy, and waste, **which can be seen in the “Relationship maps” in the appendix (p.49)**. The world of play, in other words, the content and mechanics of the game were construed based on the model of reality. The world of meaning sees the game as a medium to deploy value or effect the previously mentioned player transformations.

User research

METHODS AND TOOLS

The user research stage guided several aspects of the project, from establishing the target audience persona to the content of the game. Seven interviews were realized during this period. All participants were asked to use a new Pinterest account to search for images about certain topics. All interviewees used the same account.

Initial mind maps

Two interviews were used to generate collages and a mental map of the participants’ context, regarding their lifestyle, consumed media and political awareness. They were asked to search for images about the following topics: Free time; media, brands or people that they are following; sustainable nutrition; eco-friendly; and world challenges. **Please refer to the “Initial image maps and interview description” in the appendix (p.39).**

emotions and feelings, which can be generally labelled as *negative*. Yet the design intention is that of inviting players to reflect. On the other hand, a dark design pattern seeks to manipulate and harm users.

SUBSYST uses the affordances of these rhetoric and usability concepts, without the intention to harm the user. The player is required to click and *grind* more with small-scale productions in order to feed the population. On the contrary, industrial productions require less effort and a lower quantity of in-game resources from players. While both production models can trigger events where players lose resources, it is the industrial system which has drastic *hidden costs*, which activate cataclysms. These are catastrophes which disrupt the system, with the objective to evoke discomfort and communicate the consequences of some industrial practices.

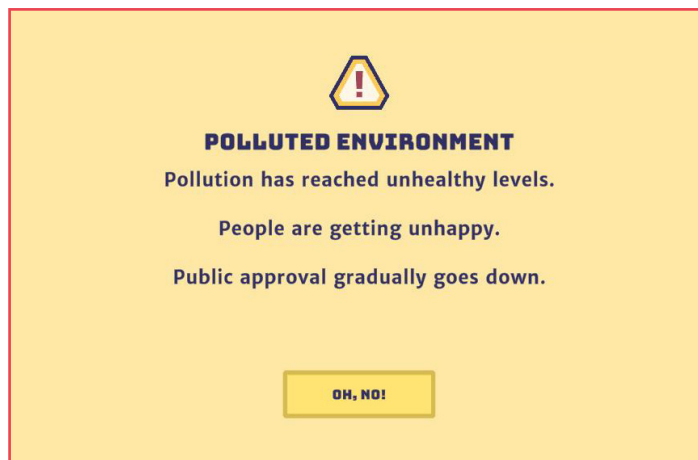

Discomfort as rhetoric tool. Different events and catastrophes can happen in the game to trigger discomfort and reflection in players.

4. Game state of the art

**Simulations
with a message**

SUBSYST's core gameplay is about producing, consuming, managing waste, and adapting to events in the social and natural environment. Therefore, the game draws elements from different genres, such as serious simulation games, management and incremental clicking games, turn-based tactical games, and strategy games. The project was also inspired by games for sustainability. **A list of the games mentioned in this section can be seen in the "Game state of the art references" in the appendix (p. 54).**

Darfur is dying is a serious game which represents the tragic and complex situation endured by refugees in Sudan. The game is a simulation where players have autonomy to a certain degree: The objective is to gather water for the characters' refugee camp, while evading militia vehicles. Yet the gameplay mechanics imminently lead to certain events: Even though the player manages to gather water, militia raids in the camp are inevitable. The game thus exposes the precarious situation of Darfur's refugees in order to prompt players to help.

SUBSYST takes inspiration from this game, by presenting an open-ended gameplay, where players can develop their production and management facilities. However, a series of cataclysms will inevitably be triggered. These events disrupt the production systems in order to convey the game's messages.

**Incremental
growth in
clicking games**

The gameplay mechanics of incremental clicking games also serve to represent the values of the project. *SUBSYST* criticizes and portrays the consequences of unsustainable industrial production models. Therefore, one of the main project references comes from *Universal Paperclips*, a

web-browser incremental game, where players produce clips. (Spoiler alert), as the game progresses, it is possible to produce clips from any material in the universe. *SUBSYST*'s economy system was designed after observing the robust resource flow in *Universal Paperclips*. An analysis of this game's economy system can be observed in "Universal Paperclips analysis map" in the appendix.

SUBSYST also presents incremental features, however its design shows progress and information through visual resources, such as its UI, the world's color scheme, and animated 3d objects. For example, the color palette of the environment is intended to give information about the current resources and pollution in the system; for example, the game world acquires warmer colors when the amount of produced food is higher than other resources; when pollution reaches high levels, the ocean becomes darker.

In the *SUBSYST Simulator*, it is possible to upgrade different products. Each one of them has different cost-benefits or trade-offs. Some may pollute more, while others may absorb pollution, for example. This feature was inspired in the specialization system of *XCOM: Chimera Squad*. Although both games are different, *SUBSYST* uses specializations to offer players different gameplay strategies.

Other references for the project are turn-based strategy games. *SUBSYST* draws inspiration from the happiness meter in *Civilization V*, in order to visualize the public approval of the population, which reacts to food consumption and pollution levels. *SUBSYST* also uses a time-based system to regulate the production and consumption flow of resources. This was inspired in *Civilization Revolution 2* turn-based system, which limits the amount of available resources every turn.

**Specializations
in tactical
games**

**Strategy games
and managing
resources over
time**

**Player
choices and
consequences**

Reigns and *A Dark Room* are examples which include consequences and events as part of their design. In the first case, the player controls several monarchs throughout time. Each queen or king can end its reign in a peaceful scenario or a catastrophic outcome. These events happen based on how resources were managed throughout the game.

A Dark Room has an incremental game structure, where some events affect the resources of the player's camp. For example, if the player chooses to "ignore" the noises in the camp's storage room, a lurking creature pollutes the supplies. Some moments later, a portion of the camp's population dies from disease; the population is important for the production of certain resources. Nonetheless, if the player "investigates" those noises, this catastrophe is prevented.

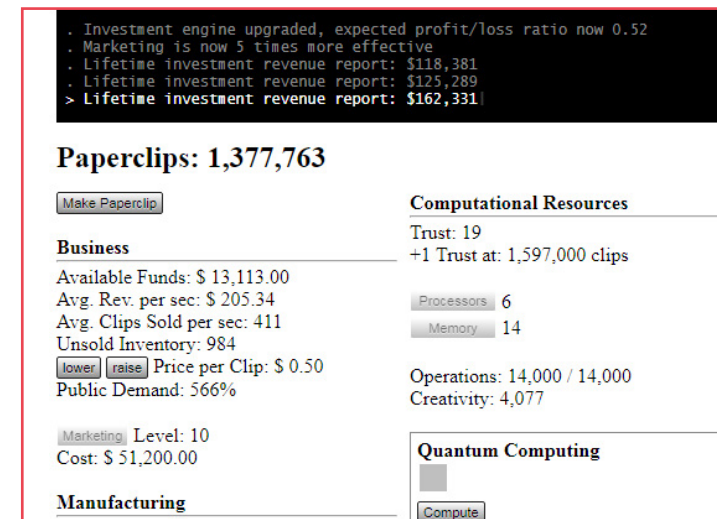

Universal Paperclips screenshot. Image retrieved from https://universalpaperclips.gamepedia.com/Universal_Paperclips_Wiki

These games inspired the cataclysm system in *SUBSYST*. Permanent disruptive events can be triggered based on the number of certain upgrades. These system disruptions may require the player to change his or her strategies to keep sustaining the production and the population.

Games for sustainability and representations of society and capital

The list of references would not be complete without games representing sustainable futures and societies. *Tradeoff!* is a simulation board game, teaching players about natural capital and ways to mitigate the environmental effects of urban and rural development. *Once Upon a Tile* is a casual puzzle simulator focusing on how resources may affect society and life. *Block'hood* experiments with the design of neighbourhoods, portraying them as rich urban ecosystems, vulnerable to decay. *SUBSYST* continues the dialogue started by these games by depicting the conundrum between food, energy and waste. It illustrates some of the possible implications



Sustainability values. The paper prototype of the project was used to explore the affordances of sustainability and food systems concepts as gameplay mechanics.

linked to industrial and small-scale development. Consequently, these relationships affect the socio-natural configuration.

It was important to observe that these games represent urban villages, infrastructure and city landscapes with 2d flat-style or 3d low-poly graphics. These visual styles give infographic qualities to the environments, supporting the flow of information and gameplay. **A moodboard with the “Visual style references” and style exploration can be found in the appendix (p.53).**

5. Process

Brainstorming

Before the semester started, the project began with a brainstorming session, trying to identify relevant topics. The topic of waste and sustainability was chosen, yet a more precise subject was required. **The “Initial brainstorming” results can be found in the appendix (p.57).**

Research and frameworks

Once the semester started, the research phase began. Understanding the Transformational Framework and the Triadic Game Design worlds was essential to structure the project. In parallel, a deeper investigation to understand sustainability was underway. After looking at different leads, the project’s problem, the food and wasted resources carbon footprint, was identified, as well as the possible solutions that circular economy for food can provide. Afterwards, it was possible to determine initial references of games addressing sustainability. With this information, the master project programme was

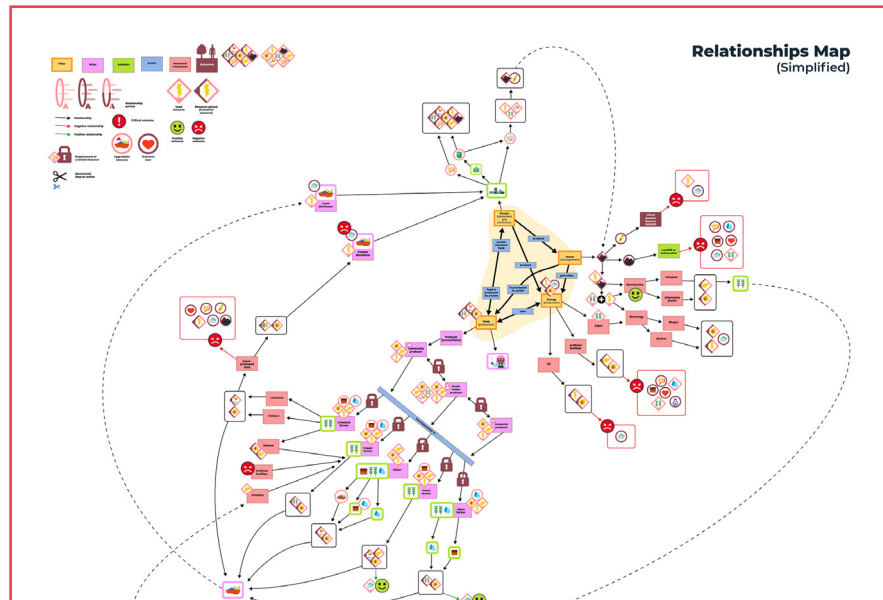

Relationship map. Several factors were involved in simulating a food system. The map can be seen with more detail in the appendix.

**Relationships:
domain, game-
play and player
transforma-
tions**

established. **The “Program” (p.30) and the “Project plan schedule” (p.29) can be found in the appendix.**

The next step consisted of defining the domain concepts, which would be embedded in the gameplay. Some of the game’s verbs were *manage, consume, produce, maintain, stabilize, circulate*, among others. The aesthetic experiences involved consumerism, growth, investment, and trade-offs. These elements were defined by the intended player transformations, which at this point, were targeting the consumer habits of players. Throughout the project, these transformations were iterated and instead focused on the players’ knowledge. These elements were given a structure, using the project’s frameworks, **resulting in the “Relationship maps”**

**User research
phase**

which can be found in the appendix (p.49). These maps served as game-design documents connecting the actors, verbs, resources, upgrades, and outcomes in the game.

The user research phase was essential for the project. The barriers to transform players were defined during this stage, as well as the communication tone of the game. Two interviews were done in a language school and five more were done in a park and a food-bar area in Copenhagen. All participants, around 30 and 45 years old, were asked about their game literacy. Some recurring genres were quiz and strategy board games. This finding would inform some of the design decisions, such as the level design and UI layout.

The two previously mentioned interviews served to map the context of the target audience. The other five interviews were applied using the ZMET. The technique was useful to visualize their world views, as well as the images that the participants related to waste and sustainable food. **Please see the “ZMET findings, collages, mind maps and insight maps” in the appendix (p.43).** This imagery would serve as a reference for the knowledge depth in the game. An entry level would involve concepts such as organic vegetables, climate change, organic waste, and recycled materials. A medium level would be related to rooftop gardens and chicken raising, while a deeper level would cover concepts like algae and upcycled waste. **Please see the appendix for the “Connection Maps” (p.47),** where the subject-matter concepts of food systems are linked to the imagery obtained from the ZMET.

**Game
references**

The project tasks would constantly oscillate between subject-matter research and game design research. Several games were studied, in order to find game patterns suitable for *SUBSYST*’s goals. Some of the games which inspired the game’s design are *SimEarth, Sid Meier’s Alpha Centauri, Polytopia, September 12th, NitroGenius,* and *The*

Finding the theme setting and crafting the paper prototype

World's Future. The main references for this project are described in the “**Game state of the art**” section.

At this point, Grow a Game cards were used to establish a setting in coherence with the main verbs of the game. **The “Grow a Game diagram”, with three ideas for world settings and themes can be found in the appendix (p.59).** Presenting these ideas to other game designers from KADK guided the selection of a near future nautical world theme. This decision was based on the theme’s appeal and its coherence with the project objectives. Then, it was possible to craft a paper prototype, which was used as a conversation starter during gatherings with game designers in Copenhagen. These conversations led to consider the potential of a narrative-focused game experience. However, due to the project’s scope and guidelines, an incremental simulation game structure was more adequate. **The “Paper prototype” can be found in the appendix (p.60).**

Availability and the game’s output

The initial game prototype was planned to be for mobile devices, using a hyper-casual structure. The intention was to design a game which could be played in different daily settings. This goal changed, in order to save time with compatibility issues with different types of mobile phones. However, the idea of making an easily available game stayed. Designing a browser-based game would wade some compatibility obstacles. Optimizing the game for browsers would later be important. PlayCanvas and HTML were potential tools or languages to build incremental browser games. However, Unity was chosen because of my previous experience with the engine and its capacity to build WebGL files for browsers.

Initial prototype

Development began. The layout of the game screen was sketched and a basic food-energy-waste loop was prototyped in Unity. A set of islands with a city and production plants was designed using pre-made low-poly



Initial prototype screenshot. One of the first iterations of the prototype. Farming, industrial and residential areas were blocked-out in the level.

The logic behind the core loop

assets. This constituted the first level design and it was used to explore the visual style for the game. The Deep Dream Generator was used to explore a painterly effect. Nonetheless, it did not fit the personality of the project. Further exploration led to a newspaper infographics-inspired visual language. The iconography of the game was also developed at this point. **The “UI process” (p.68), “Level design iterations” (p.65), “Visual style iterations” (p.62) and “Iconography” (p.61) can be found in the appendix.**

At this point, the project frameworks reached a more concrete state. The player transformations and their links with the game mechanics seemed clearer. Hence,

a deeper food-energy-waste loop was prototyped, with several in-game products and upgrades. **A series of “Programming diagrams” were drawn to comprehend the logic of the system. They can be found in the appendix (p.69).** These diagrams were used to explain the project to Michael Schmidt, who provided technical support for building the game systems.

First round of playtests

The results from the first group of playtests implied that the prototype was partially achieving the project objectives and the intended player experience. As part of the playtests, I held a conversation with Christian Laumark Hansen, game designer of the incremental game Planet Life. More details about the insights from this conversation will be explained in the **“Playtests”** section. Nonetheless, Christian’s feedback, the playtest results and a selection of cards from A Deck of Lenses guided the iteration process for the second prototype.

Balancing and iterating upon the core loop

Machinations was used to iterate upon the game’s core loop. This game design tool was also used to balance the variables in the game. After learning the concepts and functionality of the application, it was possible to create diagram representations of the core loop. It was possible to visualize the flow of resources during runtime or “quick runs” using Machinations graphs. Quick runs can simulate approximately sixteen minutes of gameplay (in its free version) within less than one minute. **The “Machinations diagrams and graphs” (containing an explanation video link, p.76) and the “Game system spreadsheets” (p.73) with the variables’ values can be found in the appendix.**

Afterwards, it was possible to complete the new core loop, with a working game economy and a cataclysm system using these diagrams. Cataclysms are triggered according to the amount of pollution and a certain



Visuals and level design iteration. Considering the camera and the visible level of detail, the environment was simplified.

Final visual style mock-up

number of purchased upgrades. **The “Cataclysm system configuration” can be found in the appendix (p.75).**

Meanwhile, the latest visual style mock-up was designed. It represented 3d models with an outline shader and responsive color schemes and textures. The outline shader improved the contrast and readability of the 3d models in the game map. The color scheme responded to the amount of resources and pollution of the game. The responsive textures, however, were not developed, since they would have affected the performance of the prototype. These responsive elements would change, based on the most prominent resource in the game. **The “Responsive color palette diagram” (p.63) and the “Visual style mockups” (p.64) can be found in the appendix.**

Second round of playtests

Different builds were made, after balancing the game several times and performing tests with previous

playtesters. The game was uploaded to itch.io in order to facilitate tests. More details about this second round of tests will be explained in the “**Playtests**” section.

Naming and logo

Initially, the game was titled *Mainstay Rigs*. A robust and square typography was used for the logo, referencing the low-poly visual language and frugality values of the project. Both words are nautical terms, denoting ropes and masts in ships. The name was intended to connote a structure maintaining or sustaining a system. However, its perceived meaning was ambiguous. After combining words related to the essence of the project, the name *SUBSYST* was found. It is an acronym of “sustainable system”. **The “Logo and naming iterations” can be found in the appendix (p.80).**

Evaluating the game’s impact

The final stage of the project involved an assessment plan. Its goal was to measure the impact of the game, regarding the intended player transformations. More details about this stage are discussed in the “**Assessment**” section.

6. Playtests

Playtests 1.0

Observations

The first round of playtests was performed with three participants, separately. A questionnaire about the general gameplay experience was applied after the gaming sessions.

The overall graphic style had a positive reception. The game also elicited curiosity in players, in order to explore its systems. Nonetheless, players found a lack of

Game designer’s feedback

feedback regarding the effects of their actions. Testers manifested frustration for the lack of clear objectives and support to understand the game’s rules. Players also disliked the fact that once resources were depleted, it was impossible to proceed any further in the game. Testers would have appreciated it if the game world had more “life” or animated elements. **The questionnaire used for the “First round of playtests” can be found in the appendix (p.81).**

Christian Laumark gave feedback for the first prototype iteration. With his comments, it was easier to identify different design opportunities. The game’s state was that of a playground, where players could develop their production stations in different ways. Seeing the game from the player’s perspective, it was interesting to have several options, such as products and upgrades, where it was possible to spend in-game money.

Nonetheless, at that moment, the learning curve of the game was too steep. It presented players with many challenges from the beginning. This meant that a slower

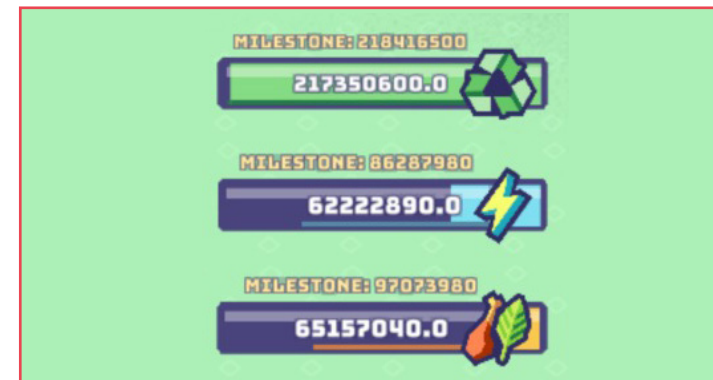

Growing too fast? During playtests, resources increased too fast or too slow. Balancing variables was essential to deploy the intended gaming experience.

and controlled pace could have benefited the game. Also, there was an opportunity in linking the public approval as a reaction to the player's actions.

Design iteration

After this initial round of feedback, cards from A Deck of Lenses were used to guide the prototype iteration. As mentioned before, players had several options to choose from, many of which did not impact the overall emergence of the game. The Lens of Meaningful Choice presents the questions: “Would more [choices] make [players] feel more powerful? Would fewer make the game clearer?” (Schell, 2008). The objective for the next prototype was to reduce the number of choices, while keeping those which had a meaningful impact.

This first lens is compatible with The Lens of Simplicity/Complexity, which asks: “Is there a way [in which the] innate complexity [of the game] could be turned into emergent complexity?” (Schell, 2008). Reducing player choices seemed to reduce the



Meaningful choices. After the first round of playtests, it seemed that the different food products in the game could provide meaningful choices for players through different costs and benefits.

complexity of the game. However, the use of meaningful choices, together with the cataclysm system's disruptive properties would add a layer of emergent depth, requiring the player to adapt to new situations.

Finally, The Lens of Time asks: “Would a hierarchy of time structures help my game?” (Schell, 2008). The next prototype would include a time feature, slowing down the flow of resources and increasing the time available to inform players about the changes in the system.

Playtests 2.0

Observations

Players from the first round found it pleasing to see environmental animations and music in the second iteration of the prototype. They also appreciated the implementation of a tutorial.

This round also served to assess the coherence of the game with the model of reality. One of the key aspects of circular economy for food is to keep materials in use. This was reflected when players found the usefulness of waste as a resource to sustain their system.

An element which intensified the gameplay experience for players were the cataclysms; for example, one of the players panicked when the system was disrupted and the resources started going down.

Design opportunities

On the other hand, the tutorial can be improved by explaining more details of the game, such as how the color scheme represents the status of the system. Another opportunity to improve the design is to find ways where depleted resources avoid a dead-end for the game. This could be fixed either by adding a restart button or by giving a minimal amount of free resources every few seconds, making a less punishing experience.

Studying player strategies was useful to identify ambiguous elements in the game. For example, the properties of biogas were designed to generate a positive outcome in the game. A player tried to build an “algae empire”, but once the biogas upgrade was purchased, his system was affected in a negative way. Such events generate the following questions: Are these situations coherent with the game and the model of reality? Is there more potential in these disruptive components? Which upgrade combinations become buffs and which ones become nerfs in the system?

Another player had a strategic playstyle, consisting of purchasing upgrades at a slower pace. He was able to have control over the flow of resources. This playstyle prevented certain cataclysms from appearing, since the player did not reach the thresholds to trigger these events. This brought the questions: How could some cataclysms be triggered, regardless of the player’s pace? How to reward players who develop their system with small-scale and sustained growth?



Playtest screenshot. Some players did not understand the color feedback of the map. However, a darkened sea was successful in conveying the idea of a polluted system.

7. SUBSYST Simulator

The SUBSYST Simulator is a web-browser incremental clicking game. It takes place in a fictional maritime urban region. The player takes the role of a regional food producer. Feeding the population and developing food production are essential tasks, while moderating their impact on the wellbeing of the environment and the society. Thus, the links between food, energy and waste are critical.

Please see the “Current prototype” screenshots in the appendix (p.122). The game includes a tutorial and can be played online in the following link:

SUBSYST Simulator

<https://eplundare.itch.io/subsyst-simulator>

**Food, energy,
and waste
management
stations**

The region has food, energy, and waste management stations, where it is possible to produce or process resources in a small scale and an industrial scale. Clicks are required for small-scale production, while industrial



Upgrades. Players can develop the production or management stations, in order produce or process resources more intensely.

productions automatically generate resources. It is possible to intensify the yield of both types of production. Each station has purchasable upgrades as well.

The food station can produce chicken and beef, vegetables, insects, and algae. Each product has a different ratio of cost-benefits. For example, chicken and beef produce high amounts of food and pollution, while algae produce lesser amounts of food and reduce pollution. Some upgrades include chicken coops, artificial fertilizer, cricket shelters, and industrial algae ponds. The energy station can produce oil in exchange for money. It is possible to transform its infrastructure to produce biogas instead. The waste management station controls the garbage collection, recycling, composting, and upcycling processes of the region.

Population, money, and public approval

The news and cataclysm system

System status and the color scheme

The game has a time structure, determining the pace of food consumption. In this case, the population purchases food every seven seconds, giving money to players and generating waste. The population and the public approval gradually grows as food is consumed. However, the population dislikes high levels of pollution.

Players may trigger cataclysms, which disrupt the game's system. As some variables increase, news are published in *The Sower*, the game's local newspaper. Its purpose is to warn players of possible catastrophes. Some cataclysms may happen if the same variables continue increasing. These events may, for example, affect the yield of food production or the cost of energy.

The game has a responsive color system. It is designed to give feedback to players about the status of resources and pollution levels. The color scheme changes depending on whether food, energy or waste management is the most prominent activity in the system. As pollution levels rise, the sea becomes darker.

8. Assessment

A series of tests were implemented to assess the impact of the game on the players' knowledge. These evaluations consisted of three stages, each one performed during a different day. The initial stage involved a first questionnaire to measure the initial knowledge of testers. The second stage consisted of a gaming session, lasting for a minimum of thirty (30) minutes. The last stage

involved a second questionnaire in order to assess the possible changes in knowledge.

The sample for the tests consisted of eight participants, between 21 and 30 years old. 50% of them play board games or video games on a daily basis. 37.5% often play games. 12.5% rarely play games.

There are three main assessed sections in the questionnaires. They pertain to sustainability, the relationships of food-energy-waste, and sustainable food productions.

The questionnaires also have other sections about the participants' opinions about society, their gaming habits, and the actions or events they experienced during their gameplay session. These other sections were not assessed, since they did not provide information to measure changes in knowledge. **The complete data and a guide to interpret the result charts can be found in the "Assessment results", in the appendix (p.82).**

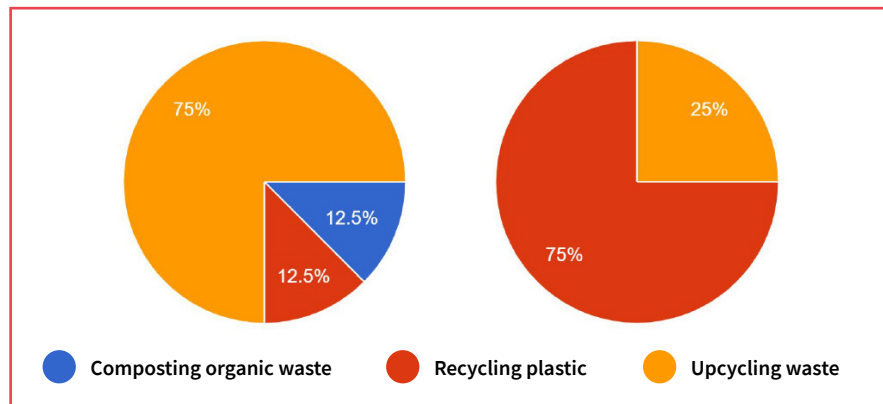

Knowledge test. In this example, players were asked about the least sustainable process between composting organic waste, recycling plastic, and upcycling waste. Before playing the game, one tester (12.5% of the participants) answered "recycling plastic" (as shown in the chart to the left), which is the correct answer. After playing the game, five more testers chose the right answer. Therefore, there was an improvement of 62.5%.

Analysis of results

The analysis of results has a simple level of depth. Future assessments could involve a larger number of participants, as well as a deeper analysis.

Eight participants completed the full test. The results of the second questionnaire showed that there was an average improvement in correct answers of 30.6%, compared to the first questionnaire. That means, that in average, 2.45 testers (out of a total of 8 testers) improved their results in the last stage of the test. For this kind of evaluations, an improvement of 25% or more can reflect a high significance in knowledge improvement.

Five questions (out of a total of eleven) showed a low impact significance of 12.5% or less. These questions (3a, 4a, 5a, 1c, and 2c) can be found in the **"Assessment results" in the appendix (p.82).**

9. Future implementations

Playtests and the assessment stage provided insights about areas of improvement for the prototype. Within the time frame left before the examination, the following tasks will be performed: Fix the knowledge units which convey ambiguous information in the game; rearrange the position of resources in the user interface for improved readability; add environmental animations, such as birds or factory emissions; explain the meaning of the color scheme in the tutorial; decrease the possibility of dead-end gameplay; and add a tutorial-skip button.

10. Learnings

The Transformational Framework provided a general structure for this project. However, because of the lack of a real client, it was challenging to determine a specific problem and define the intended player transformations. For this reason, the *SUBSYST* project required a prolonged research phase. After gathering a profuse amount of information about sustainability and the circular economy for food, using a multi-framework approach proved to be fruitful. The Triadic Game Design worlds served as connectors between the subject-matter, player transformations and gameplay.

Once the general structure of the project was laid out, the Zaltman Metaphor Elicitation Technique was a key element in the user research process. With it, it was possible to fill in the content of the game and define a recognisable visual and game language for the target audience. It was an enlightening process which uncovered insights about how the ZMET participants understand sustainability and its relationship with food.

Regarding the iteration process, one of the most important learnings from the project was the importance of finding the right design tools at an early stage. *SUBSYST Simulator* has a complex system of variables, products and upgrades. Prototyping and iterating inside Unity was a very slow process. Using Machinations to design and balance the game's incremental economy from an earlier stage could have accelerated the production phase.

Balancing the game's economy was a critical aspect of the project. The flow of resources and its implications in the game had an impact on the way in which players

interpreted the game. Playtests unveiled information of how players interacted with the game and construed the messages of the game. In this sense, it was interesting to explore the affordances of incremental games to convey a narrative of sustainability.

Since *SUBSYST* was designed with the intention of generating a positive transformation in players, one of the challenges of the project was about harmonizing play and its fidelity to reality. This dilemma was approached by defining design objectives, thus determining what elements were critical to deploying the desired user experience.

Based on the results of the assessment stage, it was interesting to observe that gameplay sessions of at least thirty minutes can generate a change of knowledge in players. This starts to give some insights on how the affordances of a simulator incremental game can impact players in a meaningful way.



Deploying meaning. The systems in the game had to be adjusted coherently in order to correctly convey the intended information and the project messages.

11. Conclusion



Knowledge structures. The incremental mechanics and the systems in *SUBSYST* served as knowledge structures, carrying information about sustainability and food systems.

The *SUBSYST Simulator* was designed for this master project. It explores how an incremental game can portray the challenges of sustainable societies and food, as well as how this kind of games can transform players. Thus, the project has been developed within the context of the UN Sustainable Development Goals.

Sustainability and food systems are subjects which involve several factors, such as types of food, producers, governments, consumers, greenhouse gas emissions, etc. The circular economy for food considers these elements and proposes ways in which production processes can regenerate the environment and reduce pollution.

SUBSYST incorporates these notions and presents a cyclical relationship between food, energy and waste.

The complexity of these subjects also resides on how audiences interpret messages for climate action. A barrier which can alienate people is a narrative of doom and hopelessness. Therefore, the game portrays ways in which food production can become efficient and friendly with the environment.

In a complementary way, the power of discomfort can be harnessed to elicit reflection in users. Thus, players can trigger catastrophes and doom in *SUBSYST*, if certain decisions are made. To increase the odds of these moments of reflection to happen, the game uses elements from dark design patterns. The game is designed to hide the natural and social costs of industrial production, making it seemingly easier to accelerate the economic and food production development, without considering its consequences.

The Transformational Framework was useful to configure the general structure of the game. This was complemented with the Triadic Game Design. This multi-framework approach made it possible to intertwine the subject-matter concepts with the gameplay mechanics, which served as units of knowledge and meaning.

The user research phase increased the depth of the project. The use of the ZMET was indispensable to support a vast number of design decisions.

Understanding how different gameplay mechanics could be combined to fulfill the project's vision was a substantial challenge. In this way, a set of elements from simulation, incremental, tactical, strategy, and sustainability games were chosen. These components converged to design the *SUBSYST Simulator*. The core loop of the game consists of purchasing energy,

producing food, selling it to develop production, and managing the pollution levels. The economy, upgrade, and cataclysm systems became the core knowledge structures of the game.

The playtest assessments provided key information to approach the research question. Is it possible to intentionally elicit knowledge transformations in players with a simulation incremental game? The assessment results showed that a thirty-minute experience with the game can elicit a transformation in players. It is interesting to observe the affordances of an incremental game like *SUBSYST*. The seemingly simple interaction of clicking buttons to increase numbers can become meaningful and, together with other game features, serve to deploy knowledge about complex domains, such as sustainability, food systems, and circular economy for food.

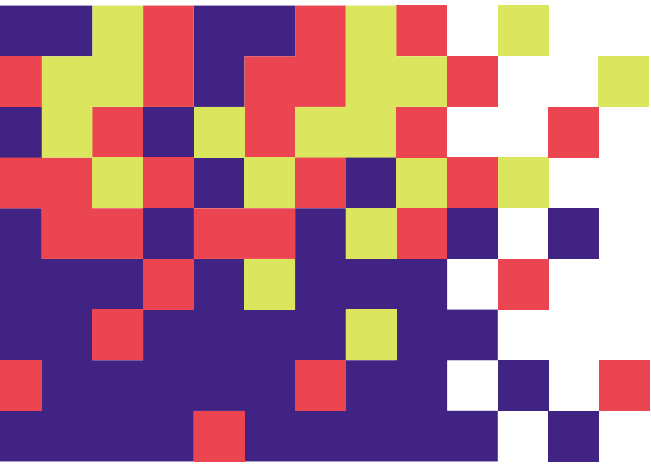

12. Appendix

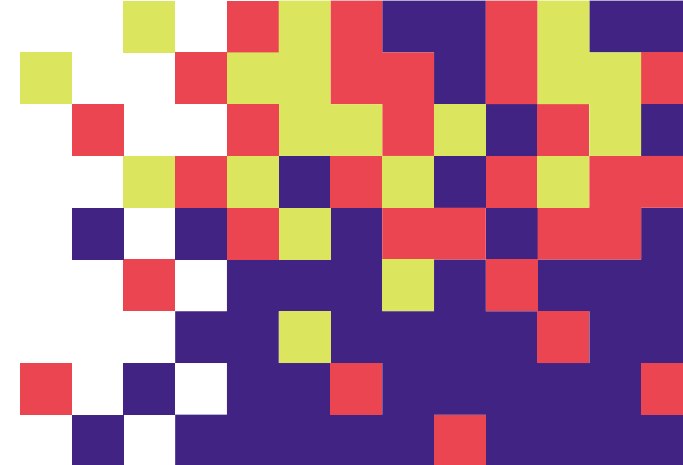



Appendix index

29	Project plan schedule	62	Visual style iterations
30	Program	63	Responsive color palette diagram
36	Transformational summary	64	Visual style mockups
39	Initial image maps and interview description	65	Level design iterations
43	ZMET findings, collages, mind maps, and insight maps	68	UI process
47	Connection maps	69	Programming diagrams
49	Relationship maps	73	Game system spreadsheets
52	Universal Paperclips analysis map	75	Cataclysm system configuration
53	Visual style references	76	Machinations diagrams and graphs
54	Game state of the art references	80	Logo and naming iterations
57	Initial brainstorming	81	First round of playtests
58	Game map sketch	82	Assessment results
59	Grow a Game diagram	122	Current prototype
60	Paper prototype		
61	Iconography		

Program

Alexis Emmanuel Lozano Angulo

06/02/20

KA4 Program Transformational game

Motivation

Design embodies two ideas for me. First, it is a praxis envisioning possible futures. Then, it is also the manifestation of ideas into artifacts. Once these tangible objects come to life, they can be explored by people. This interaction reminds me of the act of contemplating a sculpture. There's an underlying feeling of playfulness, expectation and curiosity within every step around the object. This artifact has something to offer and the user-spectator is invited to discover its meaning.

Designing a game involves drawing a "magic circle" in real life and/or in digital space. There, players give life to an alternate reality with different rules and meanings. What if this fictional scenario was a model of reality? What are the affordances of a game, strongly linked to reality? How can gameplay mechanics deploy value beyond play sessions?

I'll be working on a transformational game as my master project. The subject of this project will be sustainability and its possible solutions to aid the world. The attention will be centered around Goal 12 (Responsible Consumption and Production) of the UN Sustainable Development Goals.

It is an interesting opportunity to combine my graphic design background with what I've learned throughout my master education. My challenge will be to design an opportunity-space, which deploys knowledge and motivates players to change their behaviour or disposition towards responsible consumption.

The project also represents an opportunity to learn about user research, data-collection and interaction design. My expectation is that this will enrich my current set of competences. Hence my work could be attractive for game development companies focusing on non-entertainment games. Other design companies focused on product or service design could also be interested. The scope and project constraints will involve a decision-making process, which could improve my art direction skills.

Project description

I'll design a transformational game. The gameplay mechanics will be tightly related to research on sustainability solutions and understanding of the target audience. The objective is to encourage player transformations and enable their persistence beyond the gaming sessions.

An assessment phase will be intrinsic to the project. Studying the different states of players, before, during and after playing the game, will be indispensable. This will support the evaluation of the game's impact, to understand whether player transformations happened or not.

The resulting artifact will be a mobile game, in order to broaden the accessibility of the product. Therefore, performance and optimization will be essential criteria for the selection, development and implementation of game assets. Intuitive interaction and readability will be other design guidelines for the game interface and gameplay mechanics.

My role will focus on designing gameplay linked with Goal 12. My parallel role will be to ensure that the visual style coherently unifies the game design and supports the user experience. The development of game assets (low-poly-looking 3d or 2d objects) may be limited, due to the scope of the project. Therefore, a mix of original and pre-made assets could be present in the final product. The possible selection and editing of premade assets will be important to maintain the coherence of the visual style and the gameplay experience.

2

KA4 Program 2020

Research questions

Research question: Can I design a game that has an impact on the behaviour of players, within and after the game sessions?

Branching question 0: What are the affordances of gameplay mechanics to address sustainability solutions and impact the awareness and behaviour of societal agents?

Branching question 1: What is the effectiveness of a transformational game in changing a player's behaviour towards persistent sustainable actions and lifestyle?

Branching question 2: How can a transformational game provide a playful digital space to address responsible consumption and production?

Methods and frameworks

The project will involve a multi-framework approach, considering the Transformational Framework, by Sabrina Culyba and the Triadic Game Design, by Casper Hartevelde. An **assessment of playtests** will also be used to analyze the impact of the game. An iterative design process will be used to develop a playable prototype.

The **Transformational Framework** will help me understand different criteria, in order to transfer value from the game to the players and enable the value's persistence outside the game. It considers eight critical questions needed to design a game which transforms players:

1. What is the high purpose of the project?
2. Who is the audience and what is its context?
3. What are the intended transformations?
4. What are the barriers, blocking these transformations?
5. What is the domain or subject-matter?

6. Who or what are the subject-matter expert resources to validate the content of the game?
7. What prior works (games or other media) address the subject-matter?
8. How to assess whether the players were transformed or not?

The **Triadic Game Design** considers the relationship of three worlds: reality, meaning and play. This framework will guide me in how to link a subdomain of sustainability (reality) with the intended value or player transformations (meaning) and the gameplay mechanics (play).

A series of surveys and interviews will be employed to assess the intended transformations in the target audience. These will be used before, during and after the playtest period.

Expected results

The result of the project will be a **playable prototype for mobile devices**. It will contain a core gameplay loop related to sustainability and player transformations. A quick-guide will have been established to guide the visual and game design of the product.

There will also be an **analysis of the game's transformational effectiveness**. Such assessment will involve collecting qualitative and quantitative data from 10 to 20 players from the target audience.

This pilot project will establish the ground for **future development** and collaborations with possible stakeholders.

4

References

Culyba, S., 2018. The Transformational Framework: A process tool for the development of Transformational games. ETC Press.

Harteveld, C., 2011. Triadic Game Design: Balancing Reality, Meaning and Play. Springer-Verlag London.

Shiyko M., Hallinan S, Seif El-Nasr M., Subramanian S., Castaneda-Sceppa C., 2016. Effects of Playing a Serious Computer Game on Body Mass Index and Nutrition Knowledge in Women. JMIR Serious Games
URL: <https://games.jmir.org/2016/1/e8>

NitroGenius (2002). (Non-entertainment game). Gameplay: role-playing game for integrated nitrogen. Stakeholders: Government, Industry, Agriculture, Society). Policy-making game about solving the problem of pollution and societal and economic factors related to nitrogen in the Netherlands, while maintaining the GDP.



Splash! (ca. 2002) (non-entertainment game) Gameplay: Resource management and simulation models strategy game. The players manage

KA4 Program 2020

the space and planning of a river basin area, while considering social, economical, hydrological and ecological processes.



The World's Future (non-entertainment game). Developer: CRS & IIASA
Gameplay: social simulation, where players adopt leadership roles.
Target group: public administration, ngos, policy makers, youth
This is the world we model in The World's Future – a world in which achieving one goal sometimes comes at the cost of another, and where sometimes it serves to boost another. This simulation, which incorporates the 2030 Sustainable Development Goals, empowers players to experience how interconnected the global goals are and what the consequences are of their decisions. <https://worldsfuture.socialsimulations.org/#about>



5

Tradeoff! (non-entertainment game). Developer: Natural Capital Project
 Gameplay: simulation board game. Teams place development pieces (e.g. hotels, farms, port expansions, roads). Between rounds, teams are introduced to the tools and concepts of natural capital and ecosystem services. Teams then make decisions about replacing development pieces and adding other conservation pieces to help mitigate the costs of development.

Target group: everyone, public administration, local communities, farmers, educators, sustainability professionals

Tradeoff! operates on the premise that if we can bring more information about natural capital into decision-making. The game is a simple, introductory way for players to interact with the potential trade-offs and synergies between traditional development and natural capital values.

<https://games4sustainability.org/gamepedia/tradeoff/>

<https://naturalcapitalproject.stanford.edu/discover/our-training-program#tradeoff>

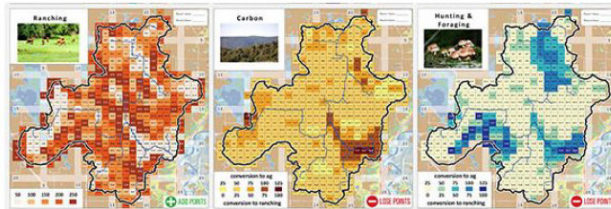

In Other Waters (entertainment game). Developer: Jump over the Age
 Gameplay: Adventure, indie game where the player takes the role of an AI, guiding a xenobiologist, "as you dive deeper and explore an underwater alien landscape. The planet's unique life, and its dark history, are yours to uncover and the bond between you and Ellery will be tested by the secrets you learn. Through this shifting narrative, In Other Waters asks questions about the nature of "natural" and "artificial" life, and investigates what it

KA4 Program 2020

means to be a human in an epoch of extreme environmental destruction. For life to continue, it must change."

https://store.steampowered.com/app/890720/In_Other_Waters/



Once upon a Tile (non-entertainment game). Developer: We are Muesli
 Gameplay: A (not so) casual puzzle life-sim. Uses tile-matching puzzle mechanics to ease the approach to the theme of sustainable development and its social consequences.

Target group: Everyone

The player's goal is to evolve and preserve life and universal wellbeing on the surface by generating appropriate resources and dealing with the complex consequences of her/his actions.

<https://games4sustainability.org/gamepedia/once-upon-a-tile/>

<https://www.wearemesli.it/out/>



6

References added after 06-02-20

Block'hood (game-for-change). Developer: Plethora-Project. Gameplay: Neighborhood-building simulator that celebrates the diversity and experimentation of cities and the unique ecosystems within them. Budding city planners will have access to 90+ building blocks to arrange and combine and to create unique neighborhoods and discover the implications of their designs.

The game will embark on a story of ecology and understanding as additional resources are always needed to unlock new blocks, configurations, and combinations to create more prosperous neighborhoods.

Throughout the design process, players will need to avoid the decay of their city blocks by making sure each unit doesn't run out of resources and become a strain on the complimentary units around them.

<http://www.gamesforchange.org/game/blockhood/>



KA4 Program 2020

Caduceus (game-for-change). Developers: Fablevision and MIT Education Arcade. Gameplay: a medicine-themed fantasy world, where you take on the role of young healers.

As they solve scientific puzzles, tweens experience the same hurdles that real doctors and scientists face in their work. They are challenged to track down the source of the disease, isolate its causes and mix and match ingredients to find a cure. As kids conquer each of the game levels, portions of their sponsors' pledges are unlocked and donated to Children's Hospital Boston.

<http://www.gamesforchange.org/game/caduceus/>



Bioharmonious (game-for-change). Developers: Amanda Dittami, Anthony Sixto, Blair Kuhlman, Craig Deskins, Cewargis Eniva, Matthew Farmer.

Gameplay: Resolve the desolation of the balance between a nature planet and machinery planet.

7

KA4 Program 2020

<http://www.gamesforchange.org/game/bioharmonious/>



A Game Dev Story (entertainment game). Developer: Kairossoft. Gameplay: Manage a game dev team to create a successful game (sell more than you spent doing it). Pay attention to the cost-benefits parameters.

Y1 M4 W2		\$330.0K	
"Racing" genre unlocked.			
Select Genre 1/1			
	Skill	Pop	Cost
Table	NEW	C	\$20.0K
Adventure	NEW	C	\$50.0K
Racing	NEW	C	\$80.0K
Trivia	NEW	C	\$30.0K
Puzzle	NEW	B	\$30.0K
Educational	NEW	C	\$20.0K
Combo with Pirate		First Try	
Yr Profit	\$-170.0K		No Project

Transformational summary

Transformational Framework

1. Higher purpose
2. Audience
3. Transformation
4. Barriers
5. Domain
6. SME
7. Prior Works
8. Assessment

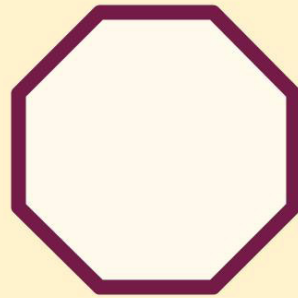

AUDIENCE



The Relaxed Strategist

- *30-45 years old. Socially active, married or living with partner*
- *News consumer. Basic to medium notions about sustainability. Attentive to politics and global affairs*
- *Experience: Strategy games, quiz games, competitive and party video games, fitness video games*

HIGHER PURPOSE



Achieve responsible consumption in cities

- *Increase knowledge of the relationships within and outside food systems*

TRANSFORMATION



Knowledge transformation

1. *Create and deepen knowledge about food systems:*
 - a. *Relationships in sustainable food system + food waste*
 - b. *Relationship with other world challenges*

BARRIERS **Player barriers**

- **General:** Misinterpretation, skepticism, b/w simplicity
- **5 D's:** Distance, Doom, Dissonance, Denial, iDentity
- **Game literacy:** Lack of experience with game genre
- **Lifestyle:** Love meat, other world issues, attention focused on personal issues, expensive, non-sustainable lifestyle, “superficial” sustainability

DOMAIN **Sustainability and food systems**

- **Food systems:** Actors, critical factors
- **Circular economy for food:** Regenerative, reduce pollution and waste, social and natural well-being
- **Responsible consumption:** Products' carbon footprint

DOMAIN **Sustainability and food systems**

- **Food systems:** Actors, critical factors
- **Circular economy for food:** Regenerative, reduce pollution and waste, social and natural well-being
- **Responsible consumption:** Products' carbon footprint

SME **Subject-matter experts**

- **Ellen MacArthur Foundation**
- **UN Environment**
- **UN One Planet Network**
- **Food and Agriculture Organization of the UN**

PRIOR WORKS



References

- **Sustainability games:** *Tradeoff!*, *Block'hood*, *Once Upon a Tile*
- **Incremental games:** *Universal Paperclips*, *A Dark Room*
- **Simulation games:** *September 12th*, *Darfur is dying*
- **Strategy games:** *Civ Rev 2*, *Civilization V*

ASSESSMENT



Transformational assessment

- **Test invitation**
- **Before and after questionnaires**
- **Game session:** *Minimum thirty minutes*
- **Organization and analysis of results**

Initial image maps and interview description

The images gathered in the maps were retrieved from Pinterest and different websites.

Initial image map (“Anahita” and “Aradh”):

The participants were Iranians, approximately 45 years old, and living in Copenhagen. They were asked to search images about five topics, using a new Pinterest account: free time; media, brands or people that they are following; sustainable nutrition; eco-friendly; and world challenges.

The following persona characteristics were drawn from these participants’ searches: They enjoy social gatherings with friends; they follow news platforms like CNN; they link sustainable nutrition with healthy food; they see technology and remote work as tools or ways to help the environment; and they are concerned about war, the political agenda of the United States, and religion.

Anahita (married)

- Nationality: Iran
- Age: 39
- Occupation: Programmer
- Games: Ring Fit Adventure (Nintendo Switch)
<https://www.youtube.com/watch?v=W15fvjCLfA>
- Note: It took a while to think about sustainable food, as well as to understand what I meant by eco-friendly
- Note: “People from outside have other concerns than GW”



Aradh (married)

- Nationality: Iran
- Age: 39
- Occupation: Programmer
- Games: Ring Fit Adventure (Nintendo Switch)
<https://www.youtube.com/watch?v=W15fvjCLfA>
- Note: “The challenge is not climate change, it is people.”
- Free Time: board games, party, barbaque
- I’m following: tech, news,
- Sustainable Nutrition / Food: diet, picky, fat
- World Challenges: plastic
- Eco-Friendly: global warming, stupidity, islam, politics, non-plastic toys

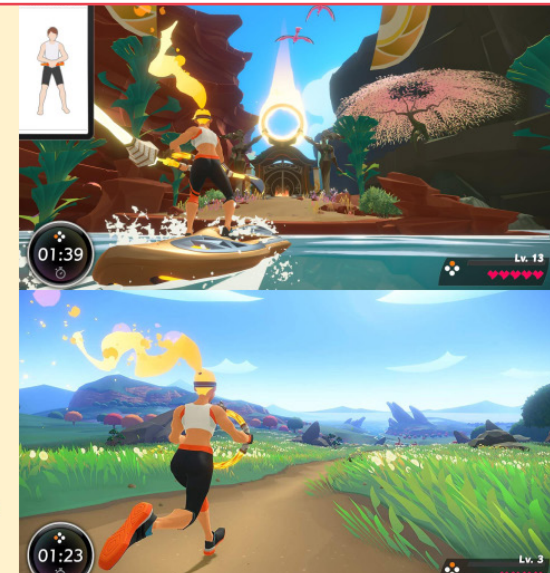



Free Time (Anahita and Aradh)

- | | |
|------------------|--------------------|
| FUN | BBQ |
| FOOD/CAKE | NETFLIX/TV |
| BOOKS | PARTY |
| PLAY | BOARD GAMES |



I'm Following (Anahita and Aradh)

- | | |
|--------------------|-----------------------|
| LIVING ROOM | FAMILY/BROTHER |
| MAKE UP | NETFLIX/SEX |
| FOOD/PASTA | EDUCATION |
| POLITICS | FOOTBALL |
| | NEWS |
| | TECH/PHONE |



Sust. Nutrition / Food (Anahita and Aradh)

- | | |
|---|--|
| VEGETARIAN PIZZA | PICKY EATER |
| GLOBAL WARMING | FAT |
| HEALTHY FOOD/GREEN/ MEAT & FRUIT | PLASTIC |
| | HEALTHY DIET/GREEN/ MEAT & VEGETABLES |

World Challenges (Anahita and Aradh)

- | | |
|-----------------------|---------------------------|
| CHINA | ISLAM |
| TRUMP | WORK/HORRIBLE BOSS |
| ISLAM/RELIGION | CLIMATE CHANGE |
| | STUPID PEOPLE |
| | WAR |



Eco-friendly (Anahita and Aradh)

HANDMADE PAPER

AIRPLANE/POLLUTION

SOLAR PANELS

PLASTIC > WOOD

VEGETATION

ELECTRIC CARS

WATER

REMOTE WORK

ANIMALS

BEING SINGLE

ZMET findings, collages, mind maps, and insight maps

The images gathered in the collages and maps were retrieved from Pinterest and different websites. Interviewees were asked to find images which they related to waste and sustainable food.

Jan

- **Nationality:** Scandinavian (Norwegian)
- **Age:** 42
- **Occupation:** IT
- **Strategy board games, quiz games:** Risk, Trivial Pursuit
- **Family man:** 3-4 children
- **Note:** Aware of produce-consume-dispose
- **Searches:** Seaweed salad, fish waste, chicken raising, rooftop terrace, rooftop food garden

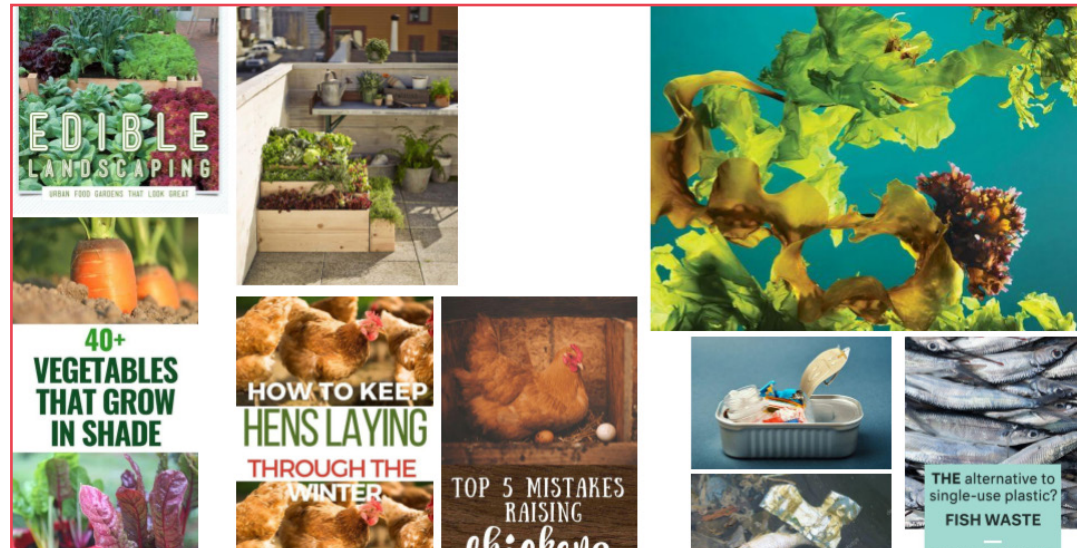

Collage. These are the images which Jan related to waste and sustainable food.



Metaphors. These are the objects or sensations which Jan associated with the images he found.

Copines (2f, 2m)

- **Nationality:** French
- **Age:** ca. 30
- **Occupation:** Marketing, Technicians (diagnostic tools and electric lines), Engineer (nuclear power)
- **Board games:** Pandemic, Scrabble, Catan. **Video games:** Mario Kart, Call of Duty, Forza
- **Note:** Searches focused on consumption, green, gaspillage
- **Searches:** Gaspillage, waste, recyclable, bee, vegetable, fruit, plastic free

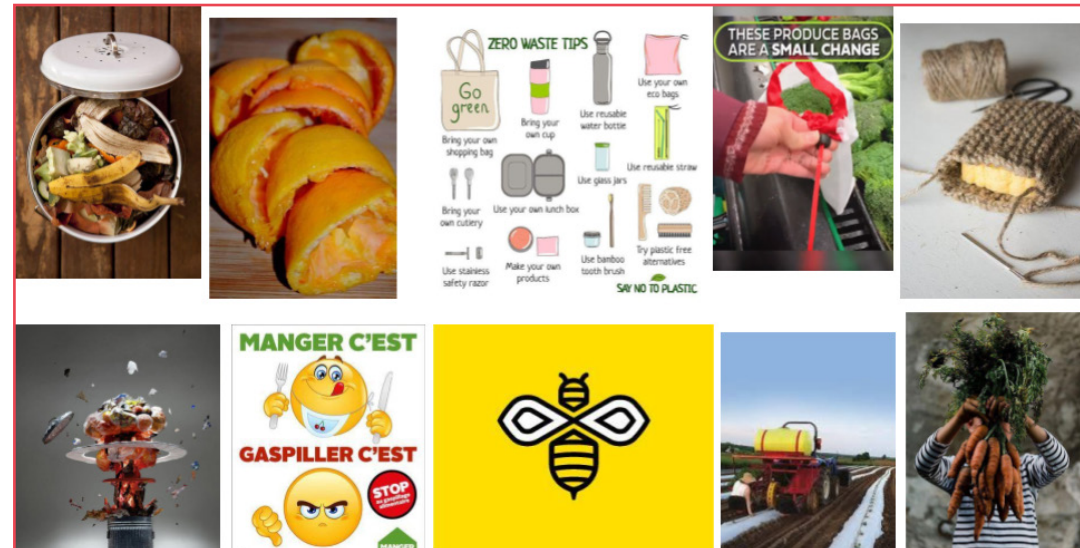

Collage. These are the images which the French couples related to waste and sustainable food.



Trash	Fruit waste	Plastic free Recyclable	Reusable items	Sponge Plastic free Humidity Water
Trash explosion	Gaspillage (waste) "Don't take a lot of food if you are not gonna eat it" Bad smell, trash	Bee Sweet Community Trade Expensive Natural products =! Pesticide, chemical	Chemical Bad product	Vegetable Real =! Supermarket products =! Meat! "Mmmm :D"

Metaphors. These are the objects or sensations which the couples associated with their selected images.

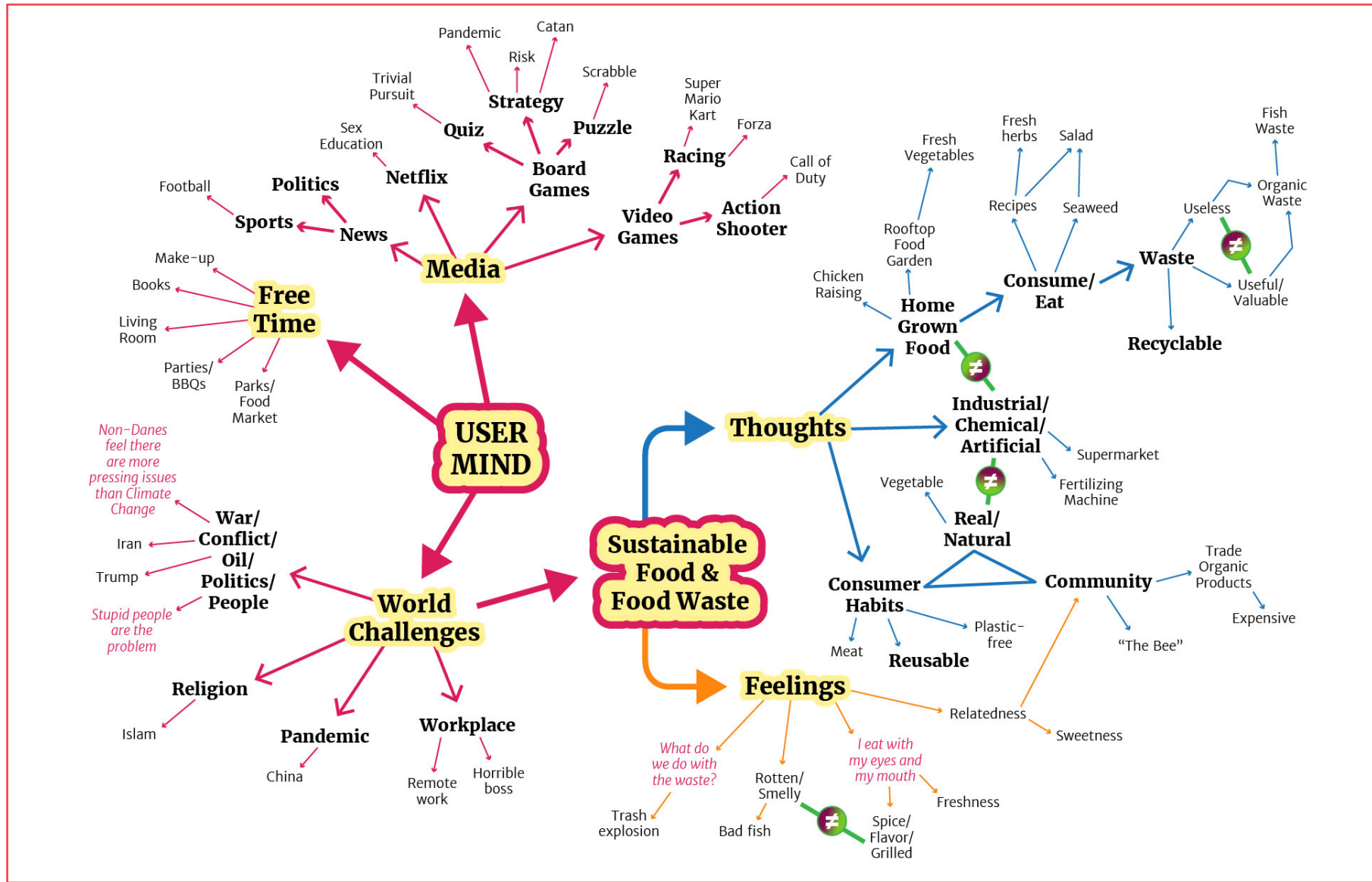

ZMET Mind map. Map elaborated based on the concepts and metaphors found during the interviews.

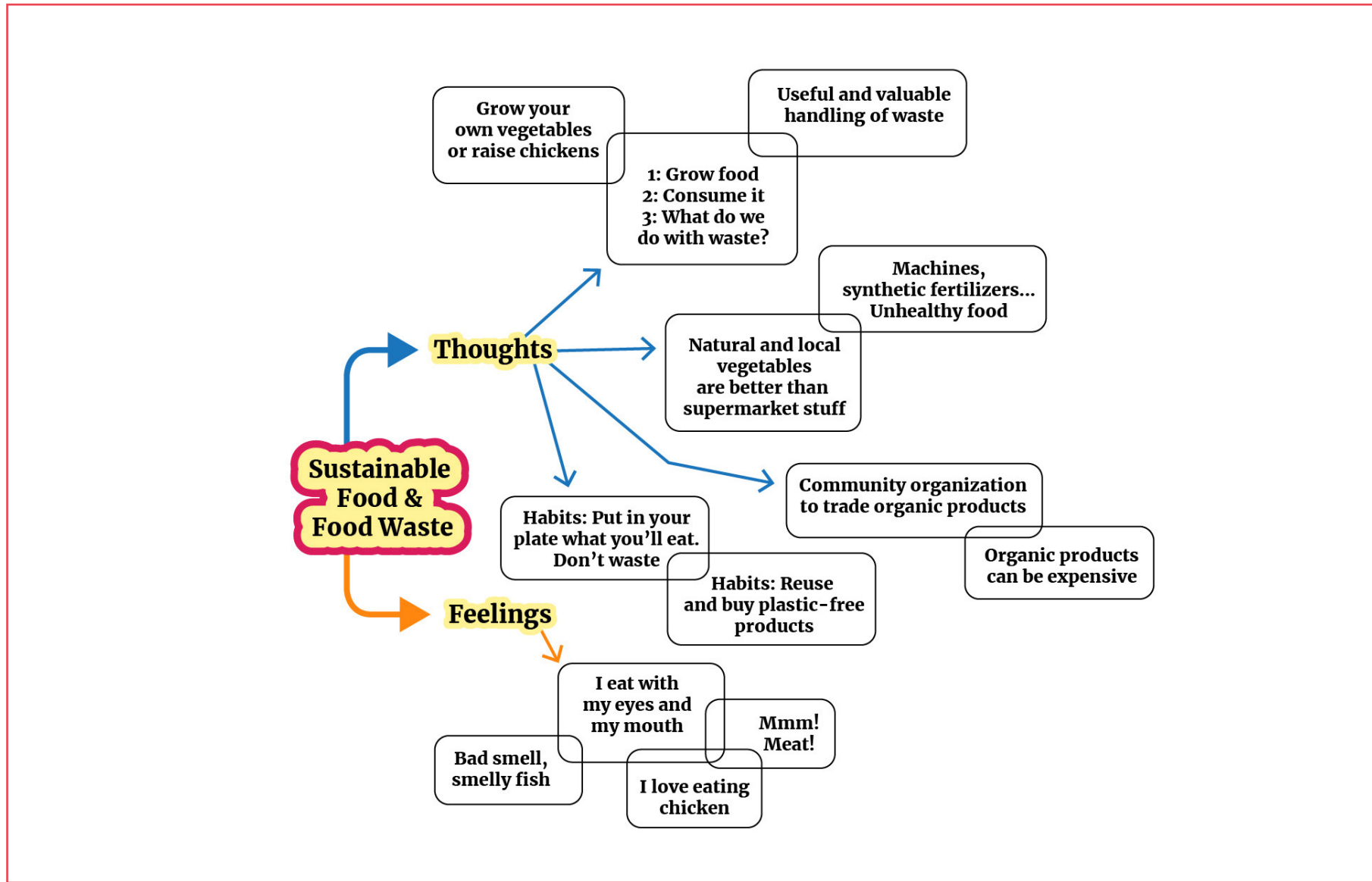

ZMET Insight map. Map elaborated based on the ZMET mind map.

Connection maps (1)

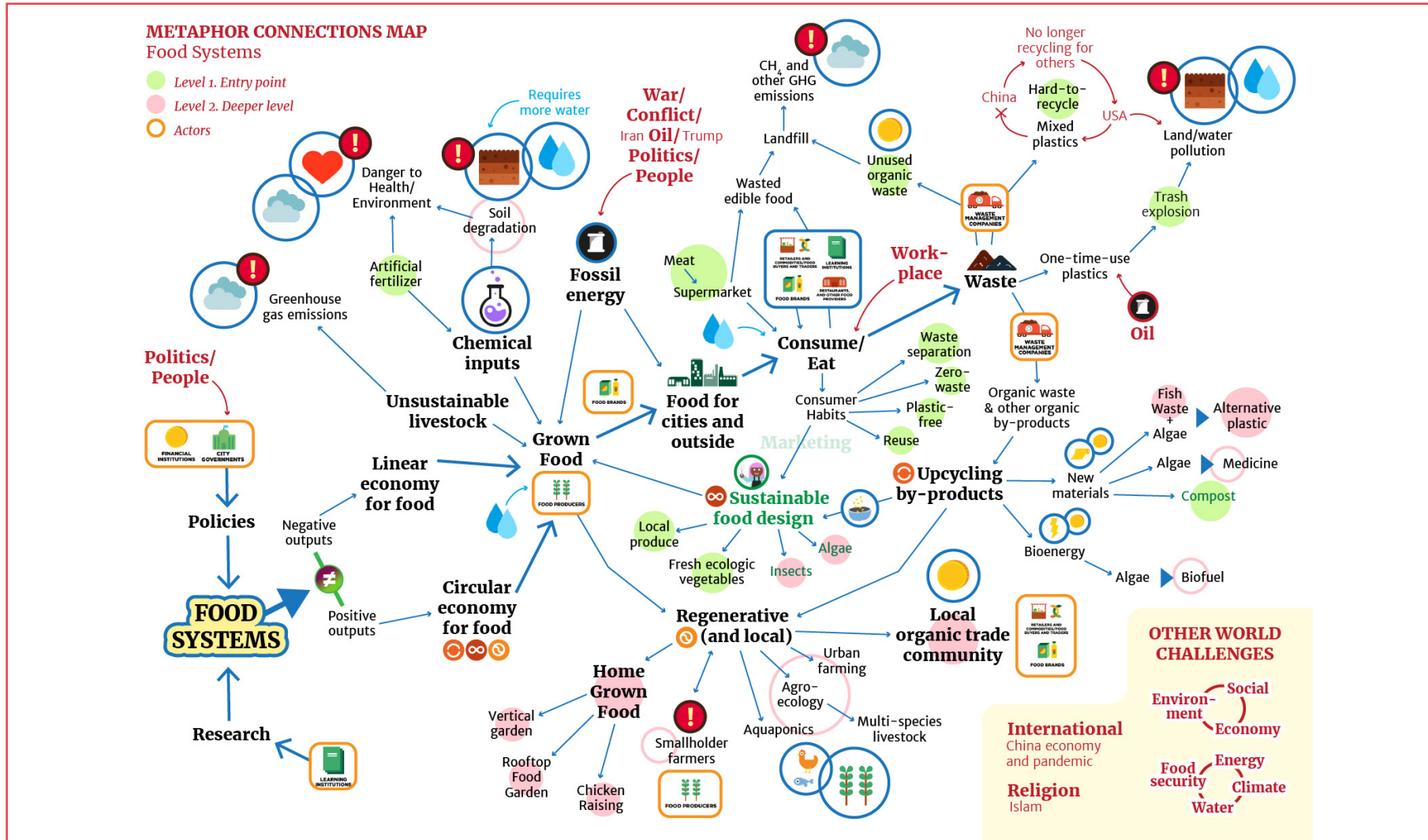

Connection map. The insights and metaphors found during the ZMET interviews were integrated with concepts of sustainability, food systems, and circular economy for food.

Connection maps (2)



Integrated connection map. The images gathered from the user research phase were integrated to the connection map. This generated a visual language for the project.

Relationship maps

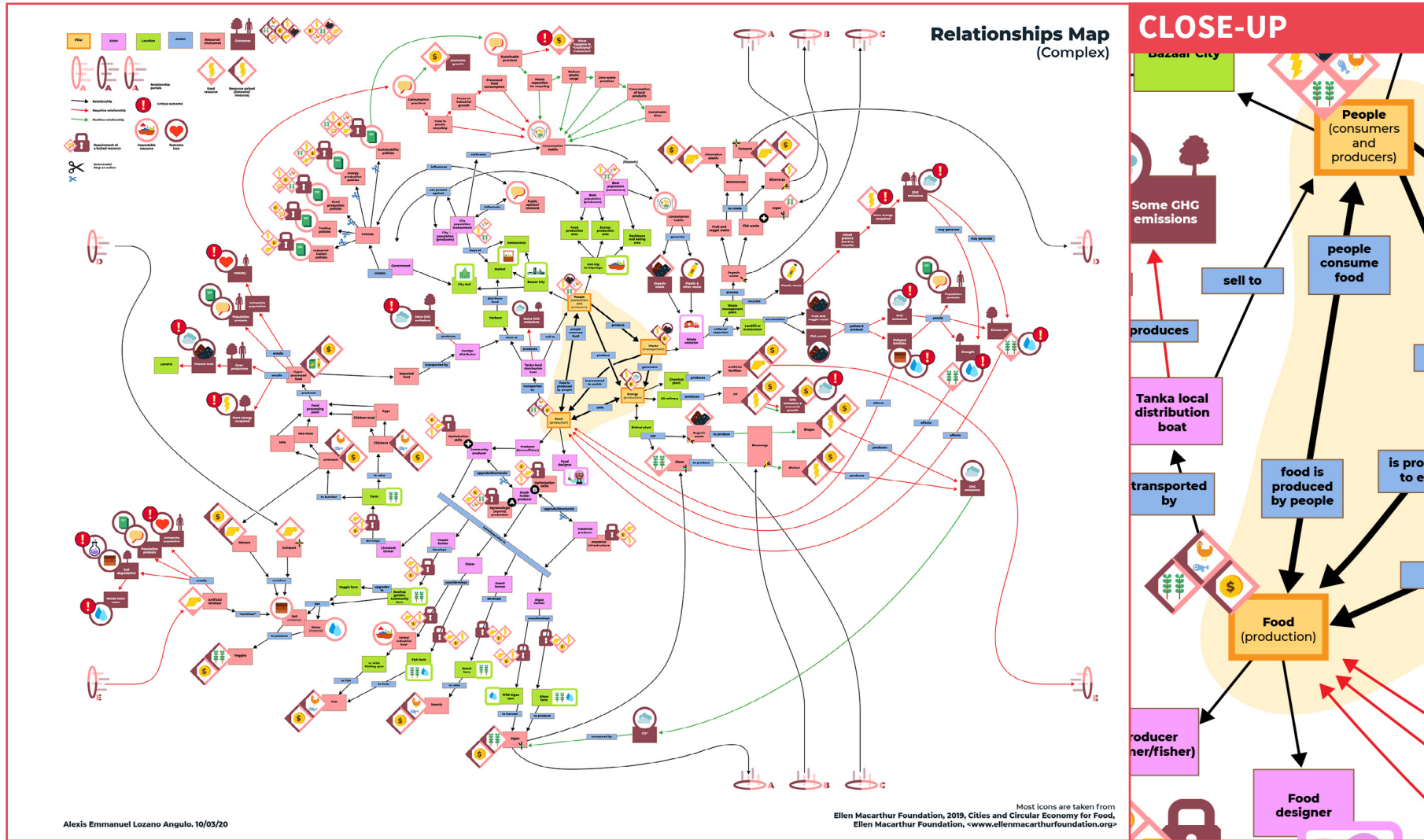

Complex relationship map. Contains the resources, actors, actions, outcomes, and locations which could be implemented in the game. This served as a game design document.

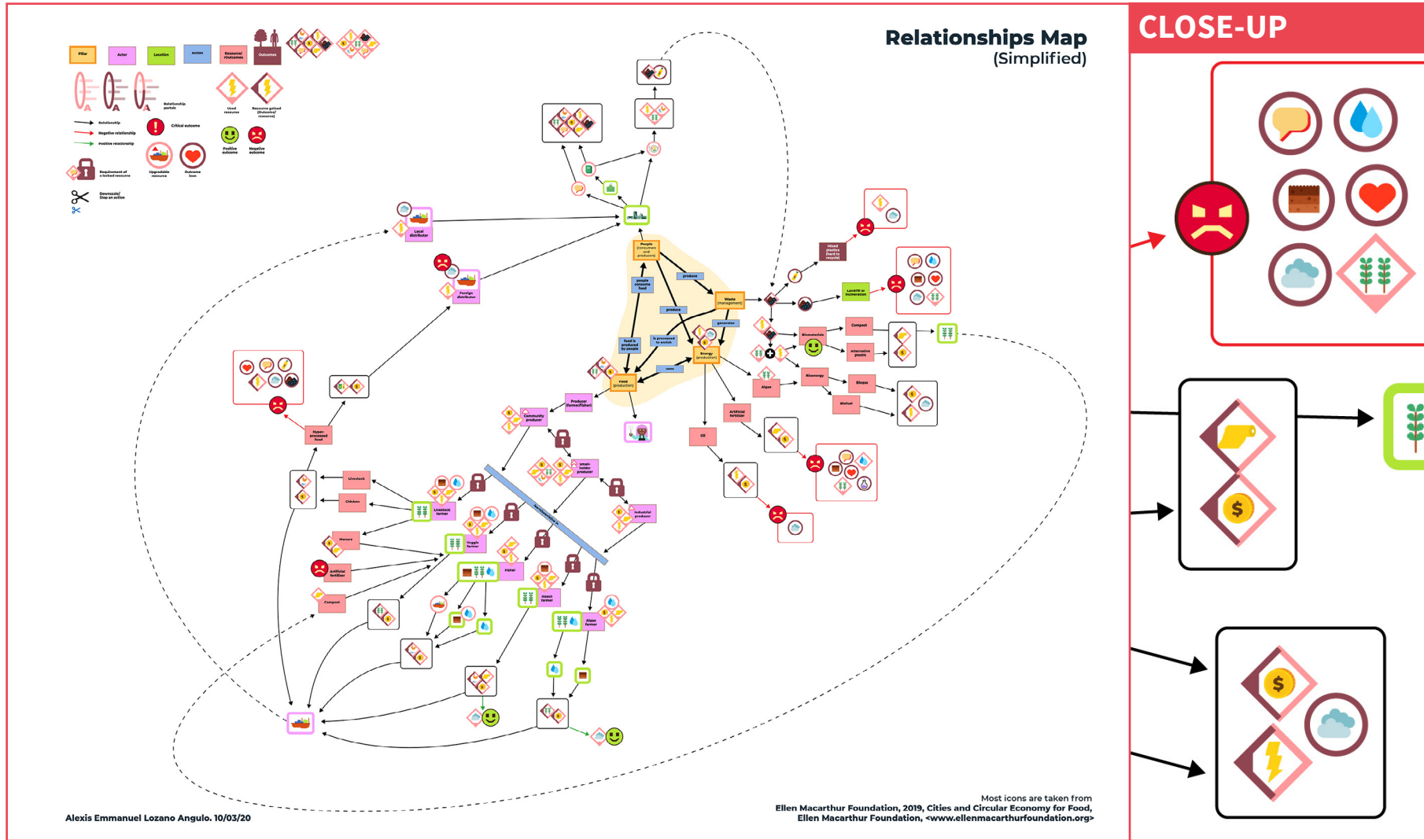

Simplified relationship map. Contains the resources, actors, actions, outcomes, and locations which could be implemented in the game. This served as a game design document.

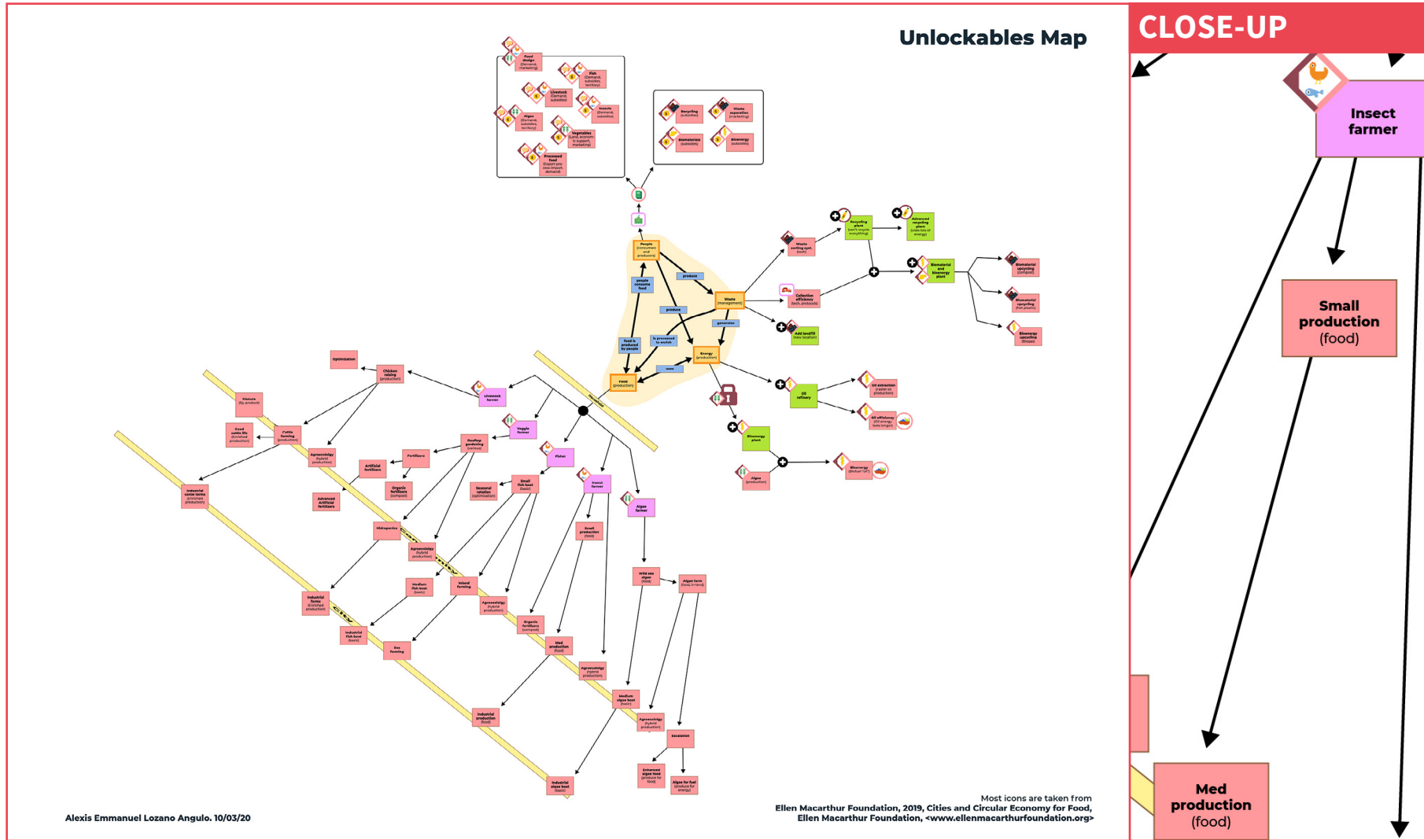

Unlockable upgrades map.

Universal Paperclips analysis map

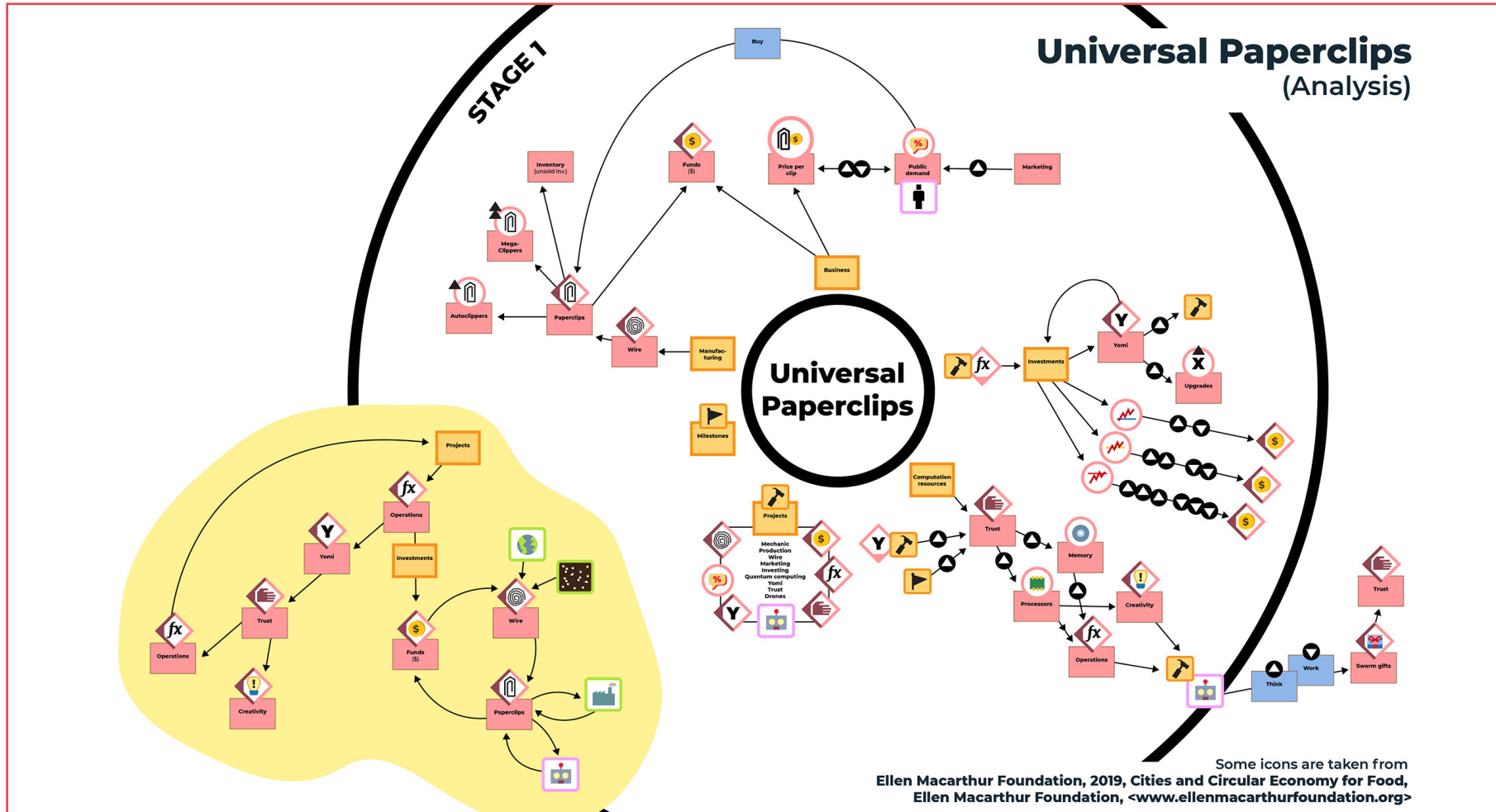

Analysis map. Universal Paperclips' economy system presents a circularity in its currency and resource flow. For example, funds are used to purchase wire, which is used to produce clips. Then, clips are sold, increasing the amount of funds. In another case, the AI operations can be used to produce Yomi. Then, Yomi is used to generate trust, which can be used to increase the memory of the AI, thus increasing the maximum limit of operations.

Visual style references

These images influenced the environmental design and visual style of the game.

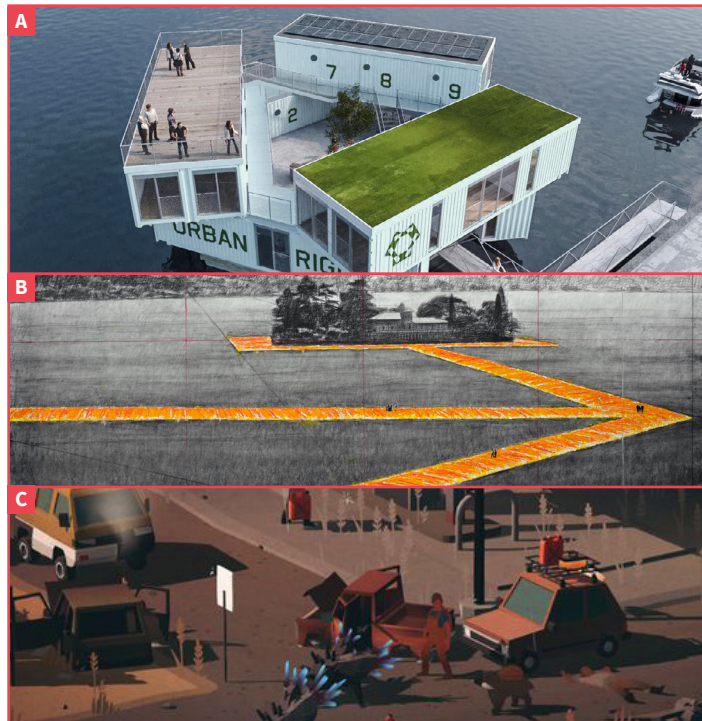

(A) Urban Rigger by Bjarke Ingels Group. Image retrieved from <https://www.scandinaviastandard.com/bjarke-ingels-group-and-urban-rigger-bring-student-housing-to-copenhagens-harbor/>
 (B) "Floating Piers" drawing by Christo. Image retrieved from <https://christojeanneclaude.net/projects/the-floating-piers>
 (C) Overland, low-poly level. Image retrieved from https://www.iphonecake.com/app_1467652041_.html

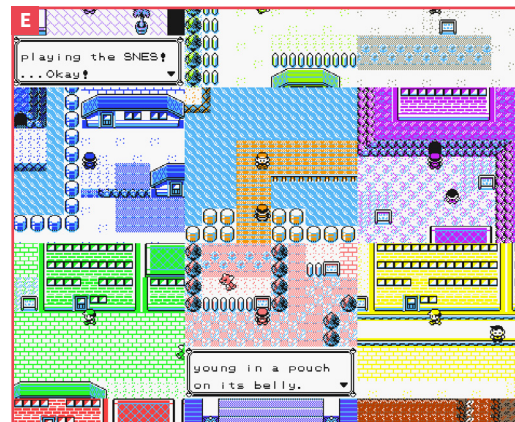
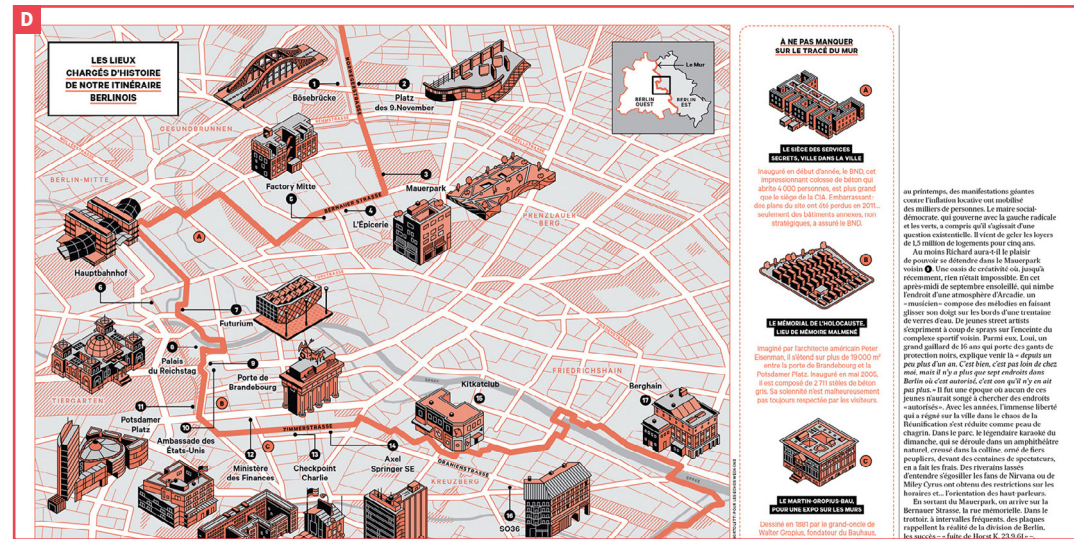

(D) Infographic by Manuel Bortoletti. Image retrieved from <https://www.behance.net/gallery/89693541/30th-anniversary-of-the-fall-of-the-Berlin-Wall>
 (E) Pokémon Yellow for the Game Boy Color screenshots. Image retrieved from <https://www.mezunian.com/category/video-games/gbc-tribute/>
 (F) "El Jardín de Fukuoka XLIII", painting by Rubén Martín de Lucas. Image retrieved from <https://www.art-madrid.com/es/obra/ruben-martin-de-lucas/el-jardin-de-fukuoka-xliii>

Game state of the art references

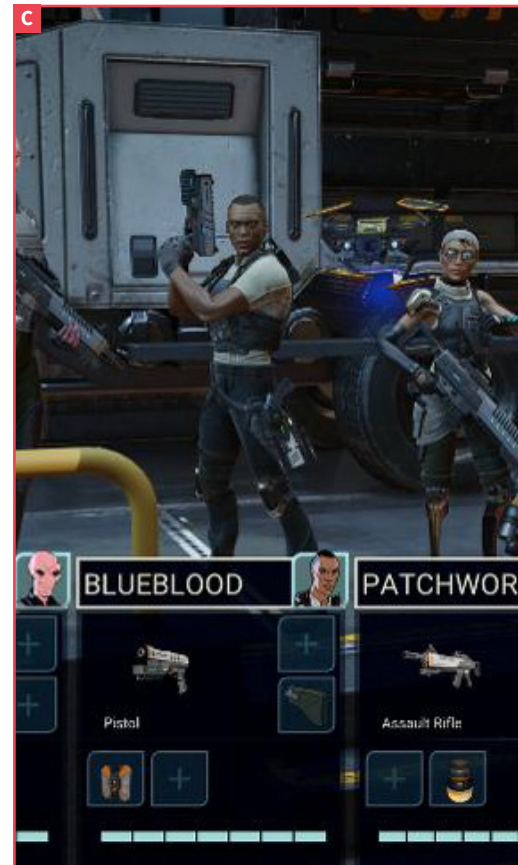
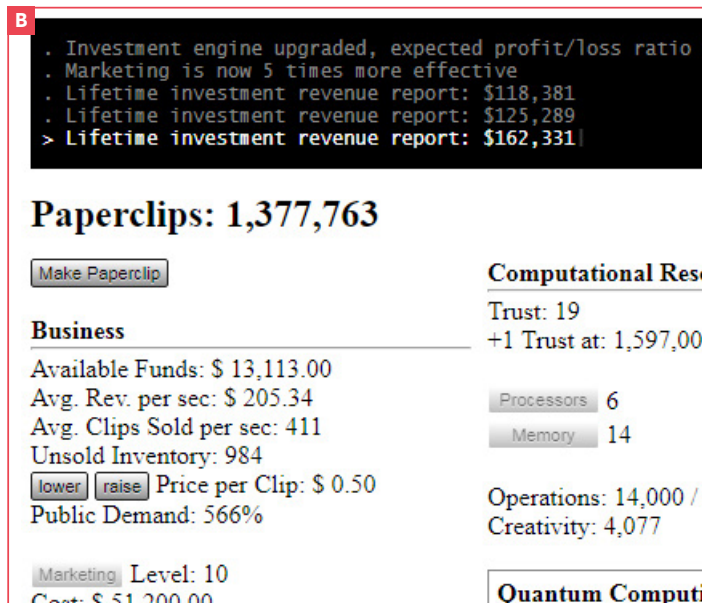

(A) Refugee camp in Darfur is dying. Image retrieved from <https://seriousgamessociety.org/2016/09/22/darfur-is-dying/>

(B) Universal Paperclips' interface and economy system. Image retrieved from https://universalpaperclips.gamepedia.com/Universal_Paperclips_Wiki

(C) XCOM: Chimera Squad has a specialization system, enabling different gameplay strategies. Image retrieved from <https://www.forbes.com/sites/erikkain/2020/04/14/a-brand-new-xcom-game-chimera-squad-launches-next-week--heres-everything-you-need-to-know/#1dbec9603ee8>

(D) Civilization V uses happiness to measure the approval of the population. Image retrieved from <https://scalar.usc.edu/works/empire-of-the-earth-piece-done-in-the-hexagonal-style-of-sid-meier/media/happiness-in-civilization-v>

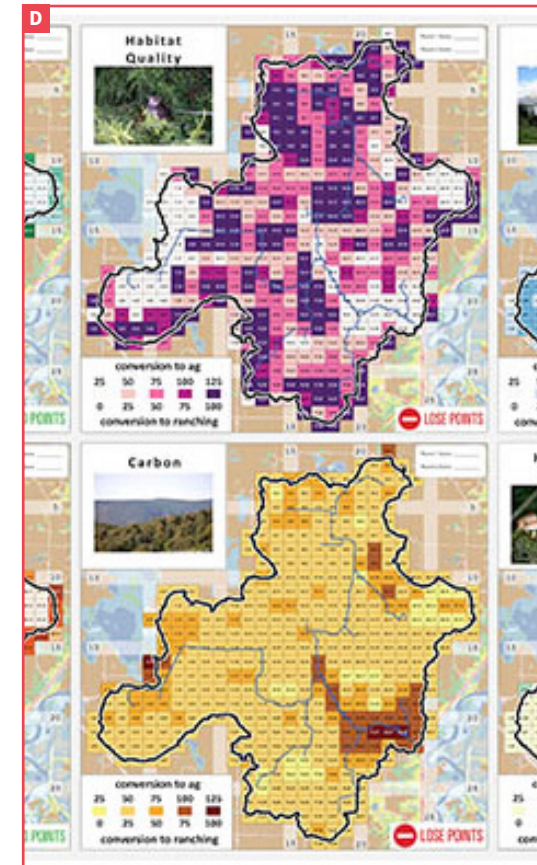
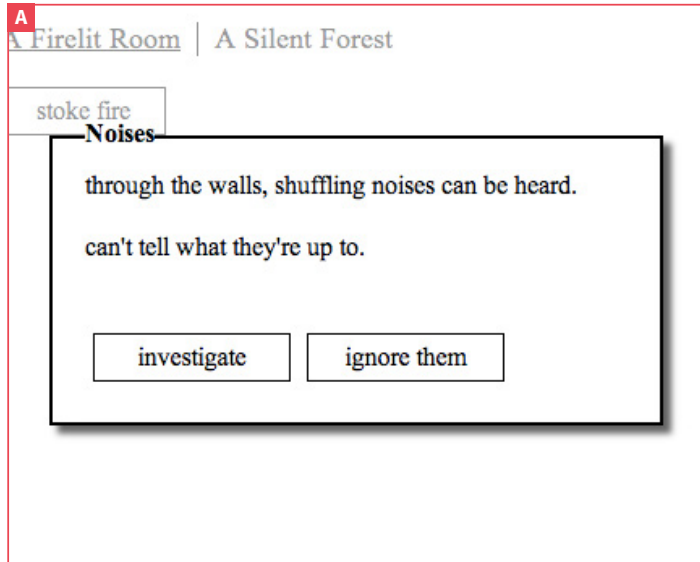

(A) Random events in A Dark Room. Image retrieved from <https://bobbyvoicu.com/saturday-game-dark-room.html>(B) Civilization Revolution 2 uses a turn-based system. Image retrieved from <https://www.ign.com/articles/2014/07/10/civilization-revolution-2-review>
 (C) Choices in Reigns. Image retrieved from <https://www.taminggaming.com/game/Reigns>
 (D) Tradeoff! Ranchland: Farm or Fallow involves balancing the restoration of natural capital and the impact of development. Image retrieved from <https://naturalcapitalproject.stanford.edu/discover/our-training-program#tradeoff>



(A) Once Upon a Tile visualizes the social impact of player decisions. Image retrieved from <https://www.wearemuesli.it/out/>

(B) Block'hood explores the concept of neighbourhoods as ecosystems. Image retrieved from <https://store.steampowered.com/app/416210/Blockhood/>



Initial brainstorming



Four main themes: Environment, play, health, or social themes.

Game map sketch

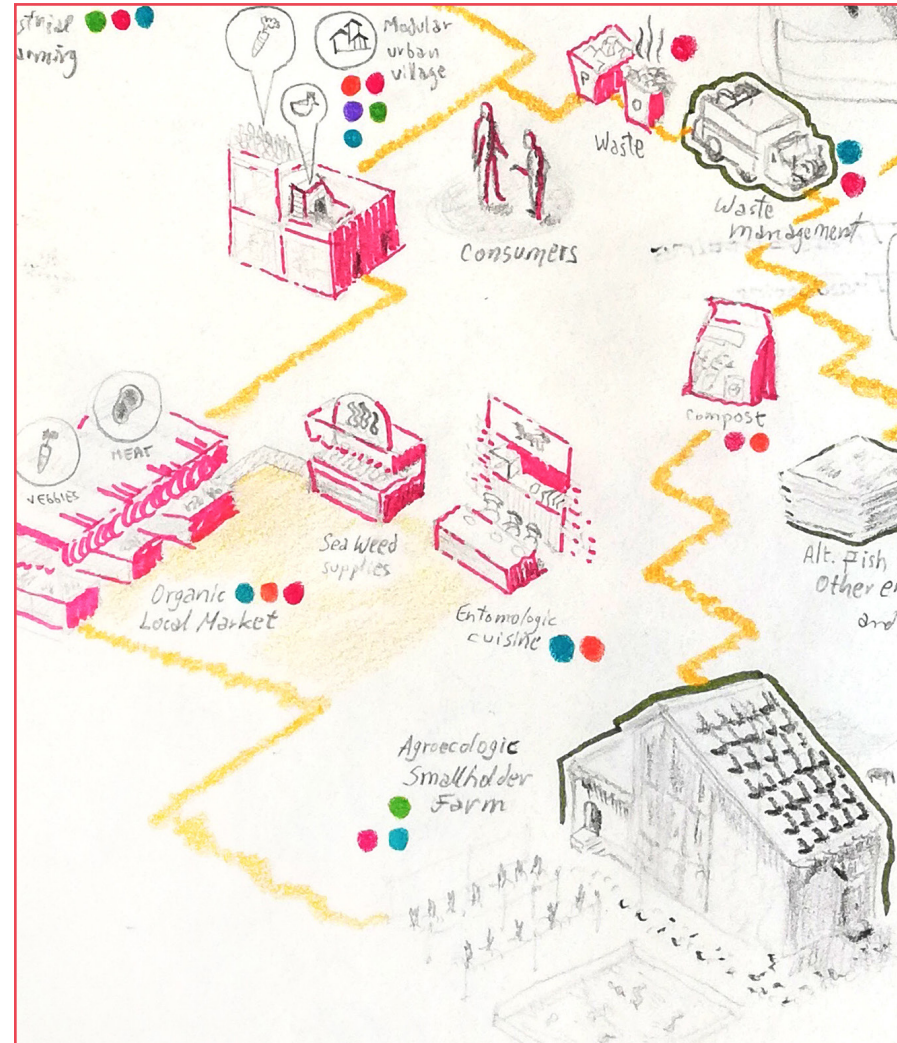
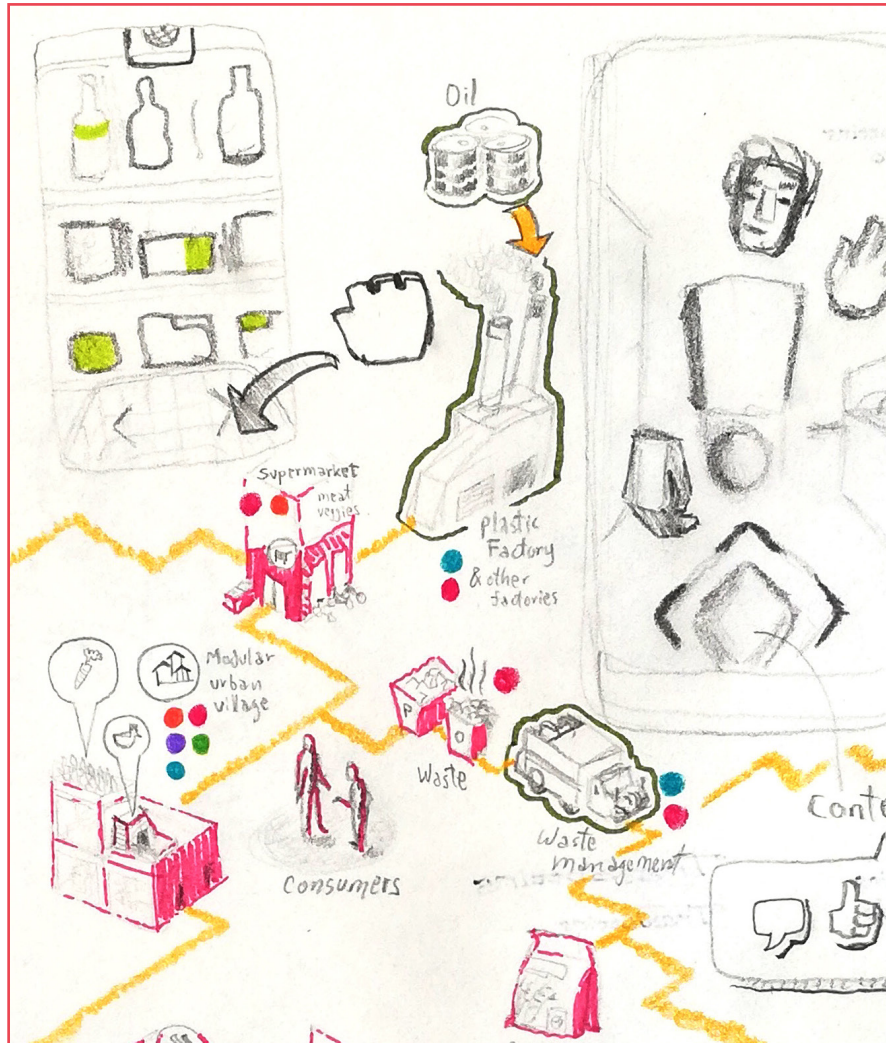

Mapping gameplay possibilities.

Grow a Game diagram

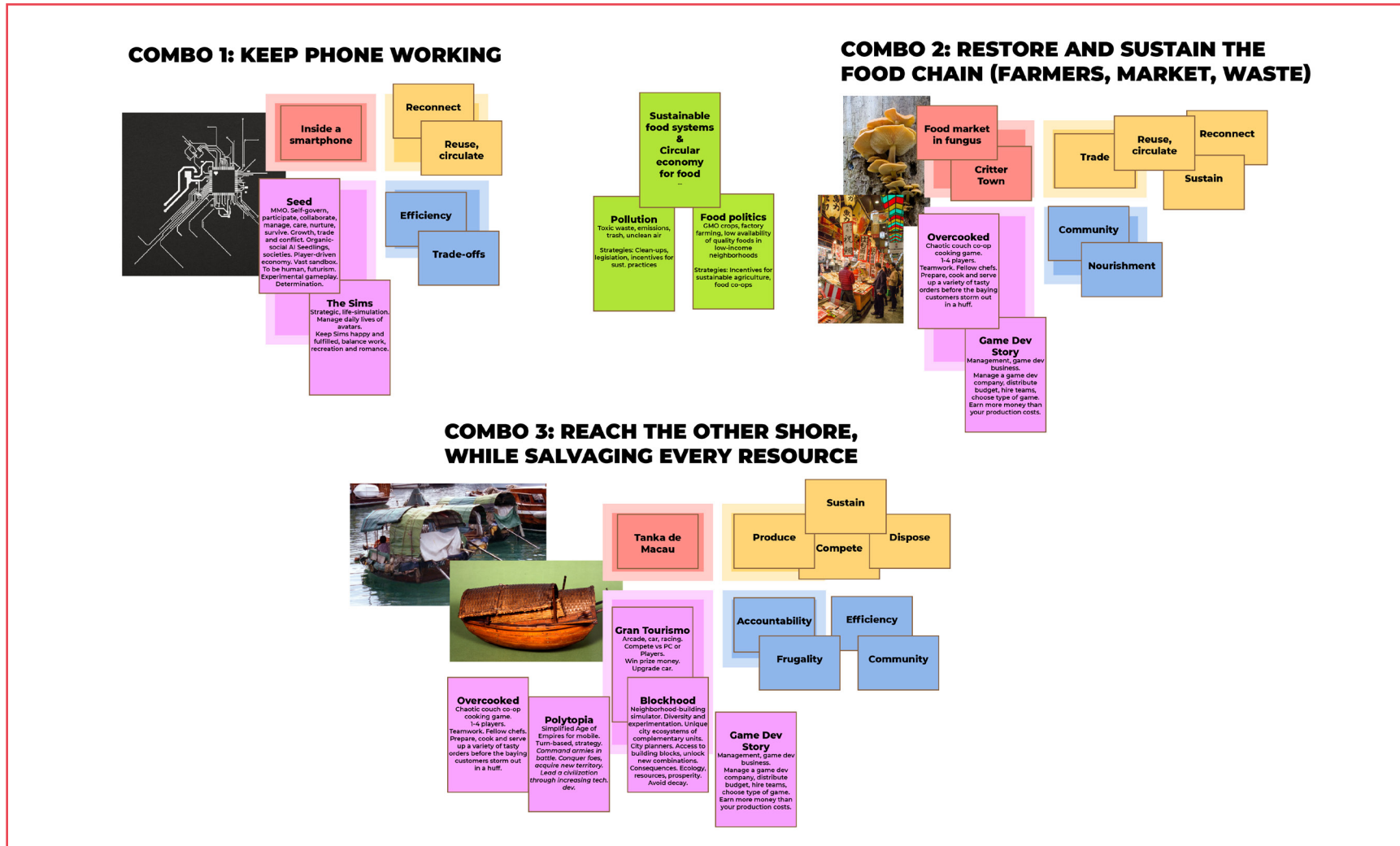

Three main settings: Ecosystem inside a mobile phone; Ghibli-like creeper town in the forest; boat-people and maritime cities.

Paper prototype



Conversation starter. The paper prototype has an embedded storyworld where climate refugees live on boats. Stranded, at the shores of cities, frugality and sustainable lifestyles are a must. Showing this prototype to fellow designers started interesting conversations at The Dubliner. Even though this was not a proper playtest and the current prototype has a different gameplay experience, it served as a hint for the potential of a possible game idea. Nevertheless, the setting, combined with concepts of sustainability generated interest.

Visual style iterations

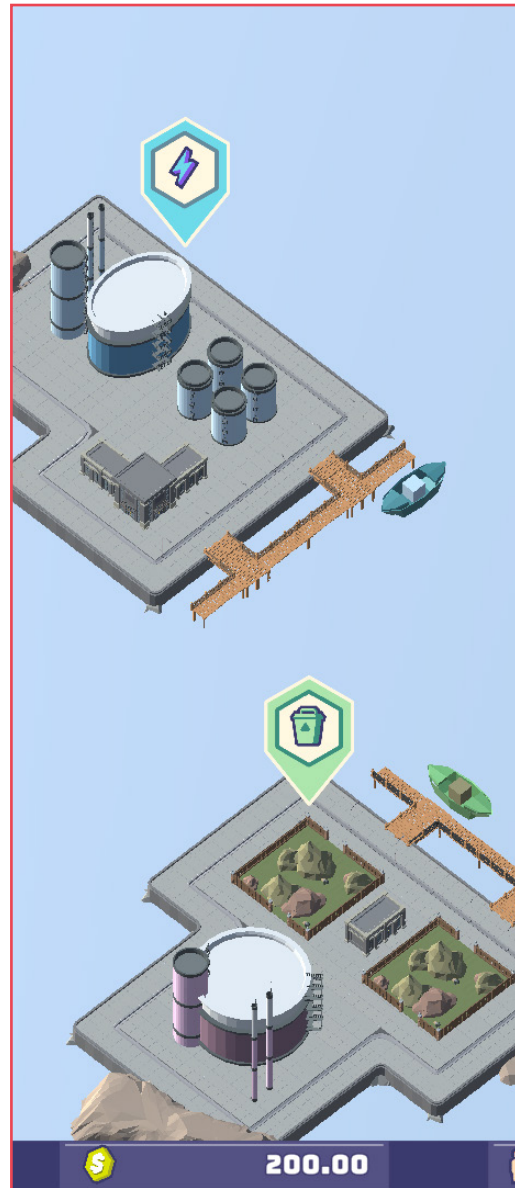
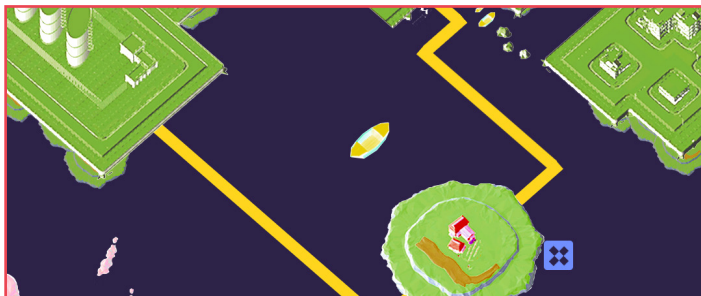
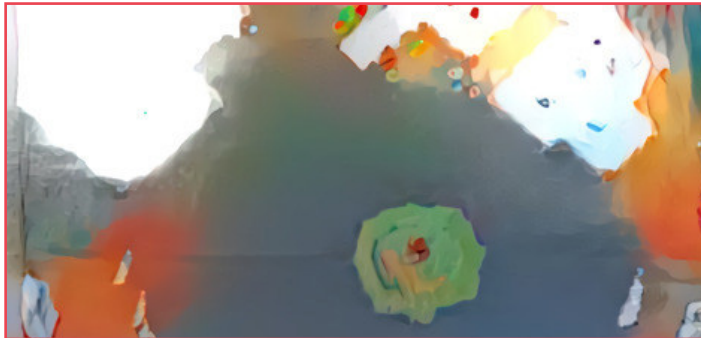

Responsive color palette diagram



(A) The initial goal was to create an accessible palette, designed for color-blind users.
 (B) Afterwards, the needs of the project led to a responsive color scheme, which would give feedback to players about the status of the game environment.

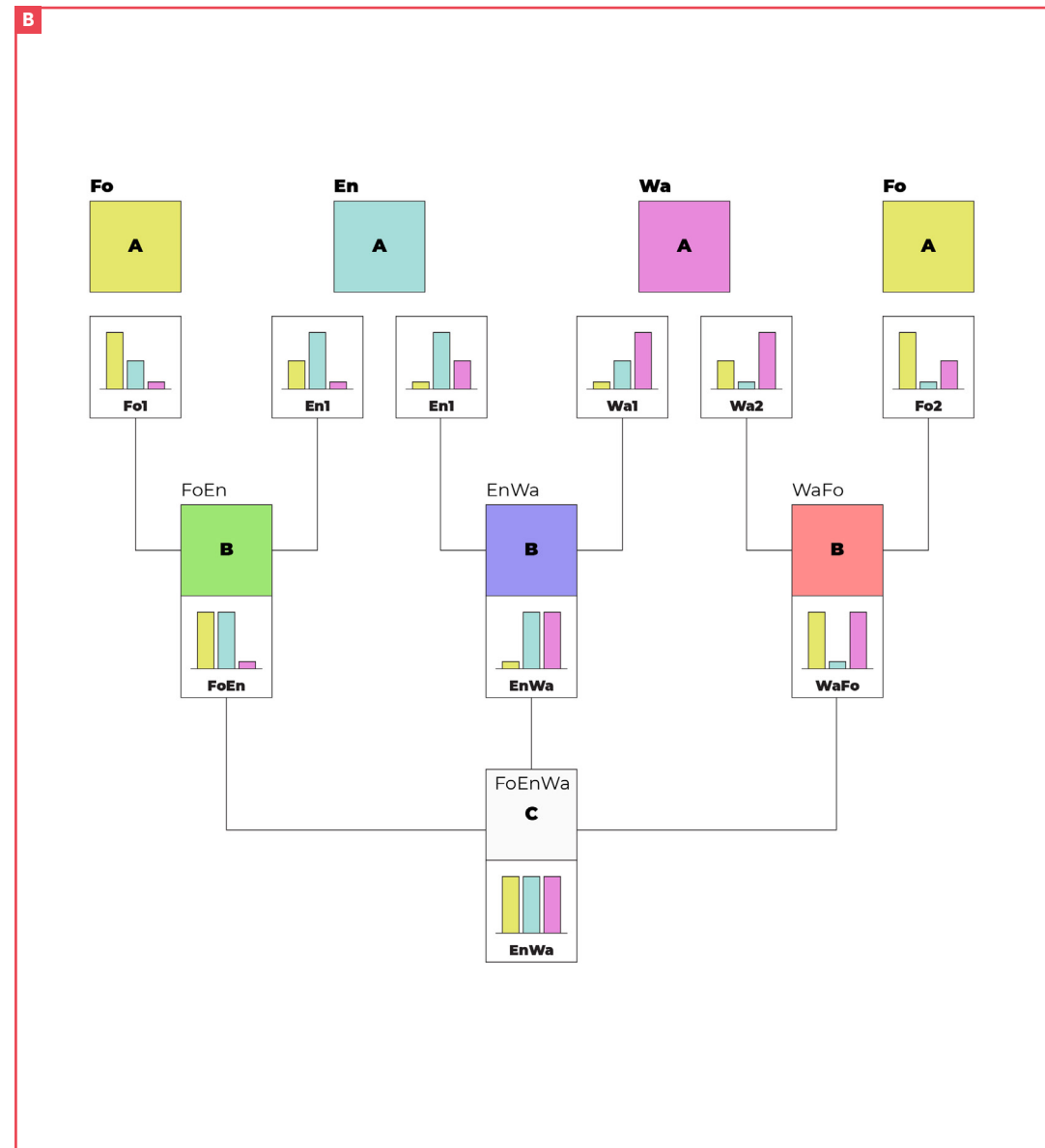

Visual style mockups

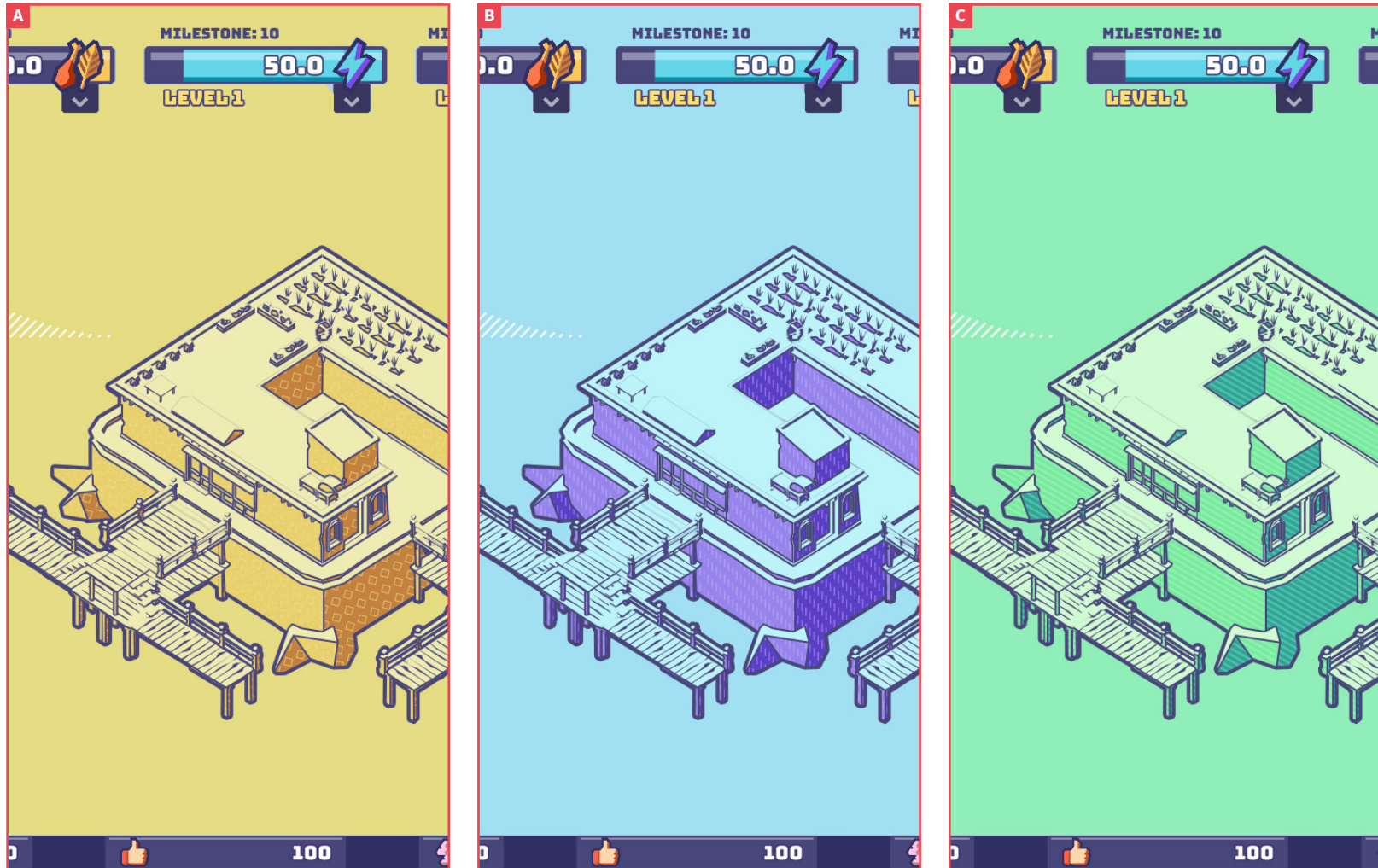

One style with responsive color schemes. (A) Mockup where food is the predominant resource in the system. (B) Mockup where energy is the highest value in the game. (C) Waste management is the most used activity in this mockup.

Level design iterations

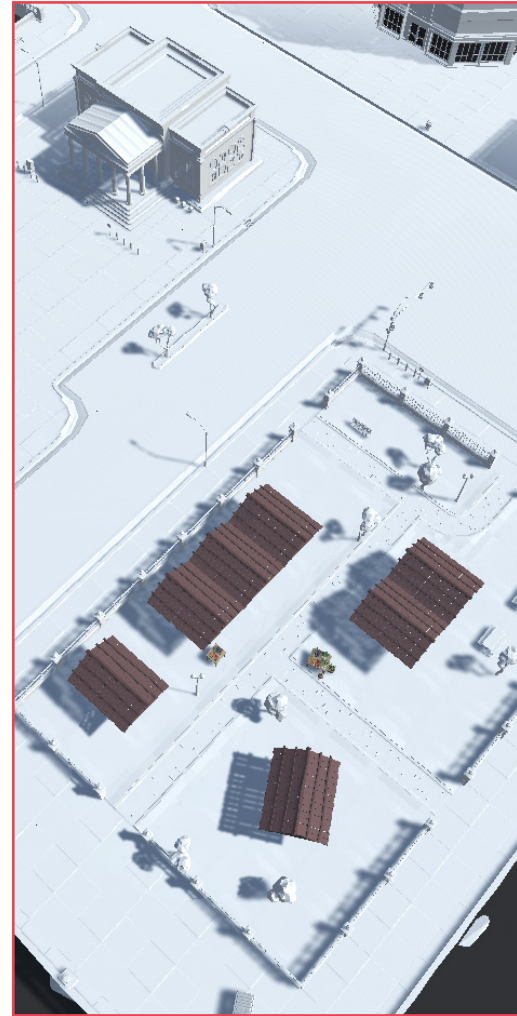
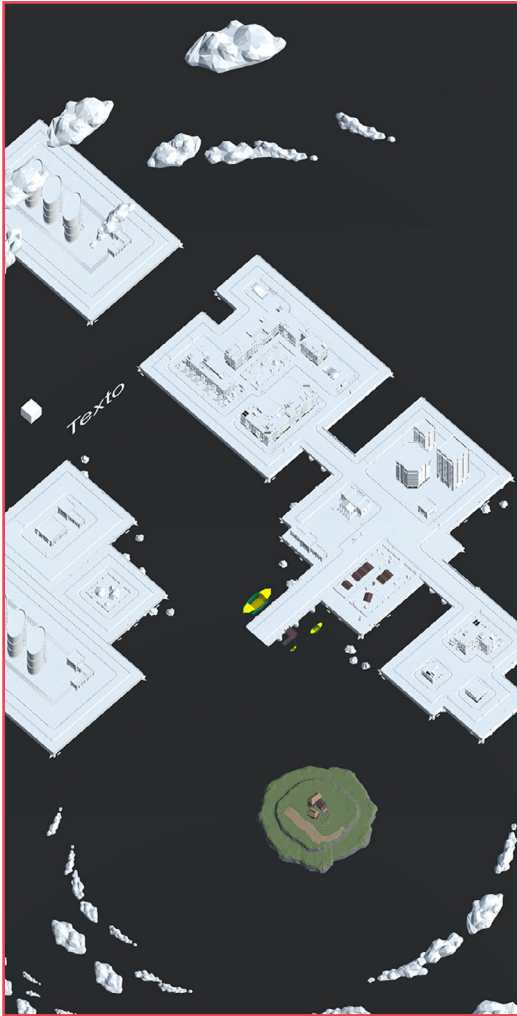





UI process

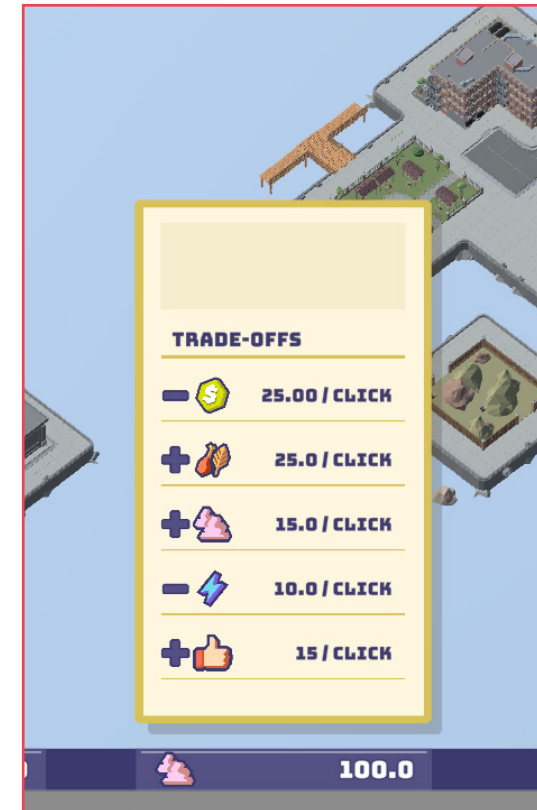
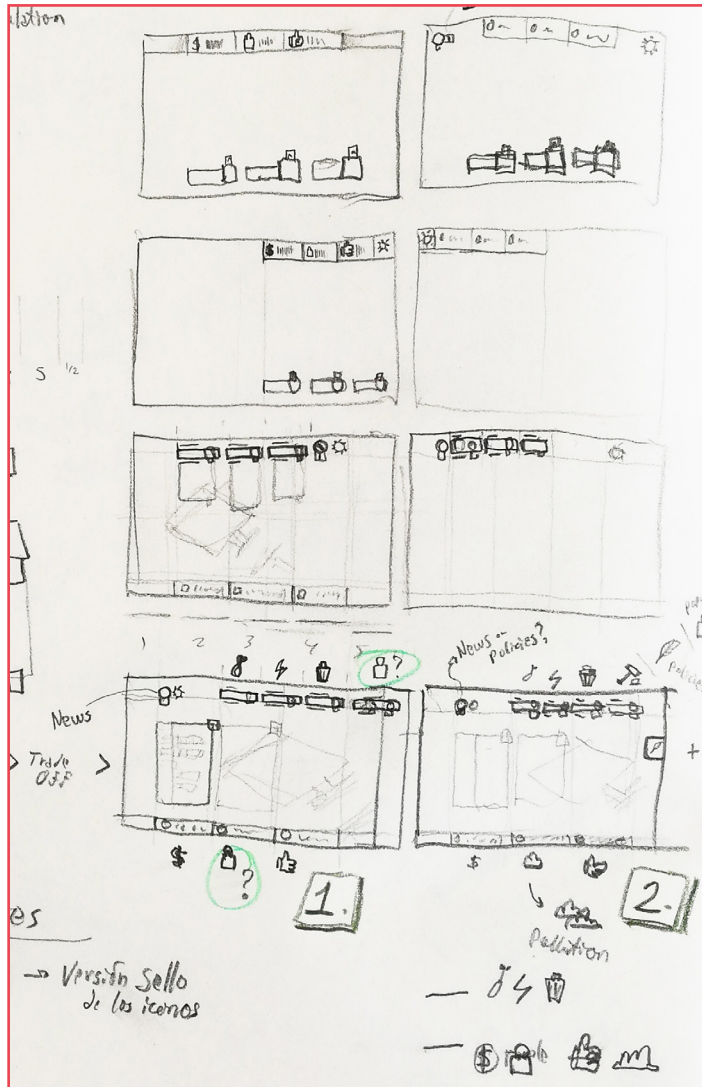

Programming diagrams

Management system sample

Currently, each resource/multiplier has a TMP.text and a float.

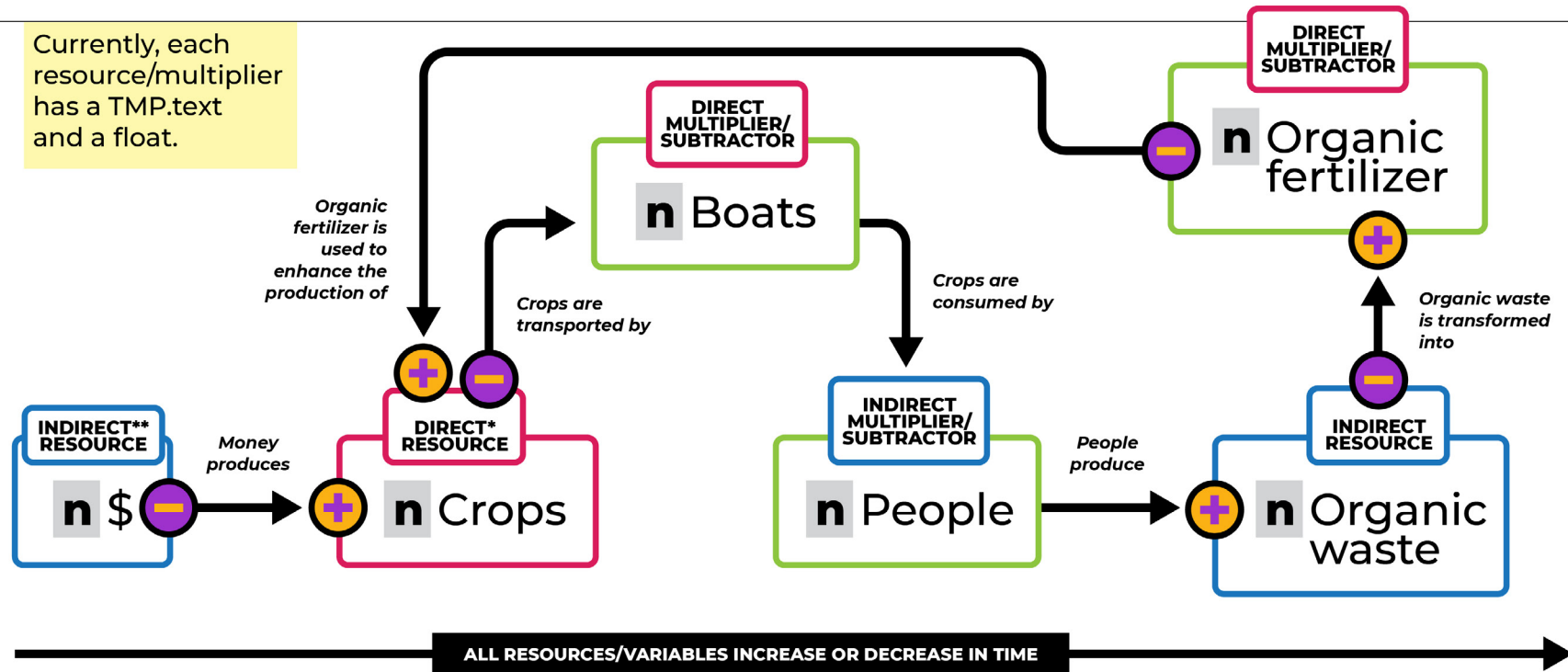

*Direct: The player increases/decreases a resource/variable directly with a click (later it's automated through purchases).

**Indirect: The resource/variable is increased/decreased through another resource/variable.

Variable analysis

- Is it possible to create a component, where I can easily connect a "head variable" with the variables affecting it?
- Is it better to have an Event System?

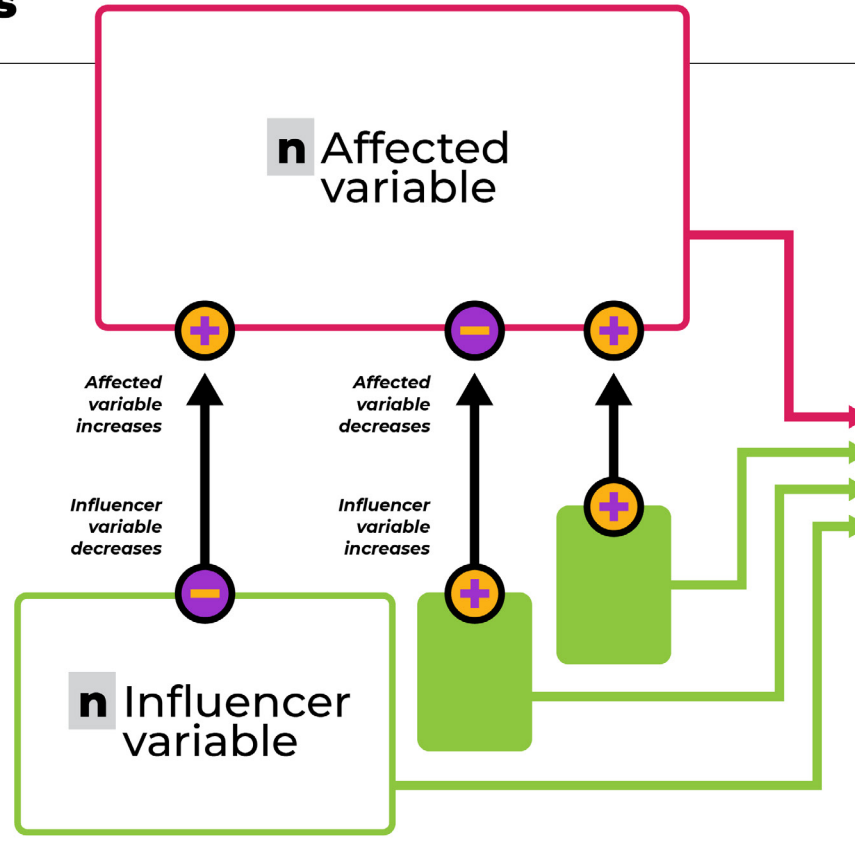

(Random screenshot from Inspector).

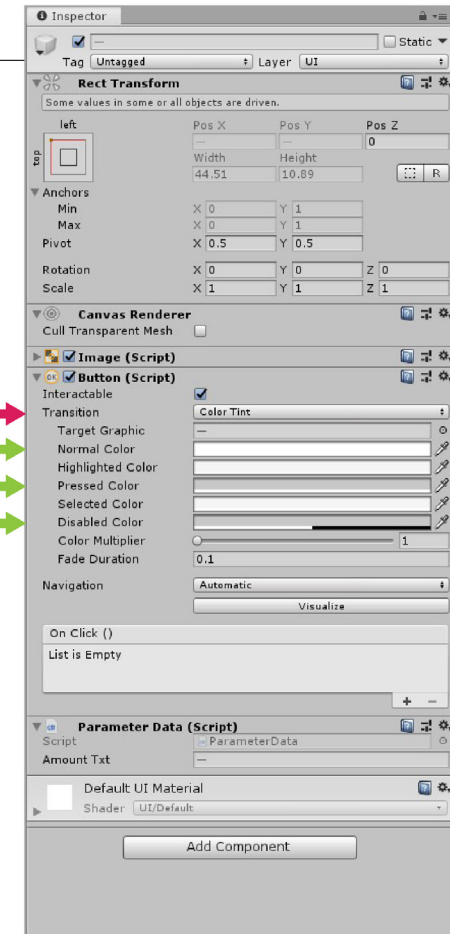

Connecting elements. Descriptions of how buttons affected products and upgrades in the game.

What does what to whom? (Classes and their gameObjects)

HIERARCHY

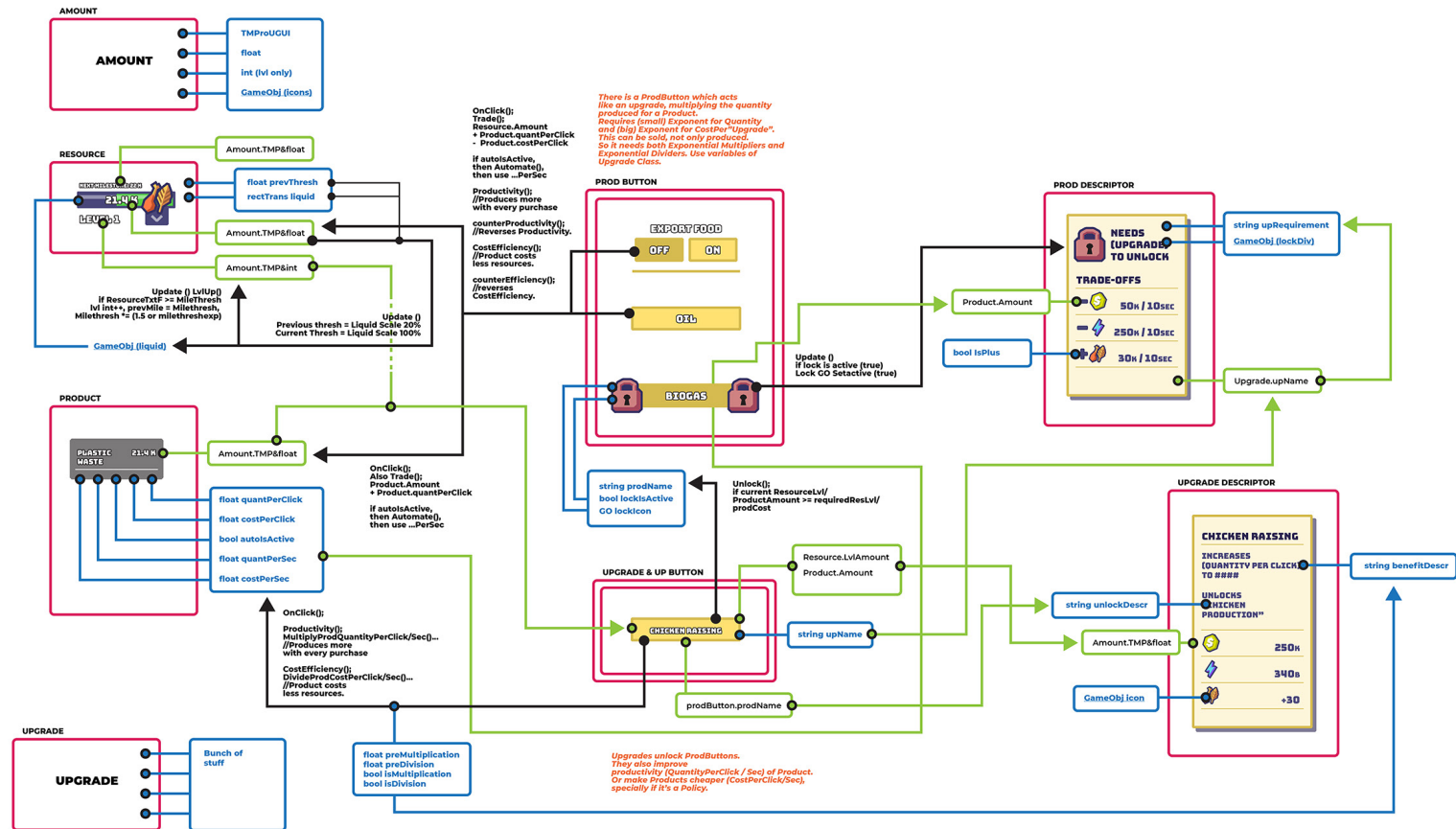

Connecting variables.
 Diagram of how resources were supposed to be intertwined.

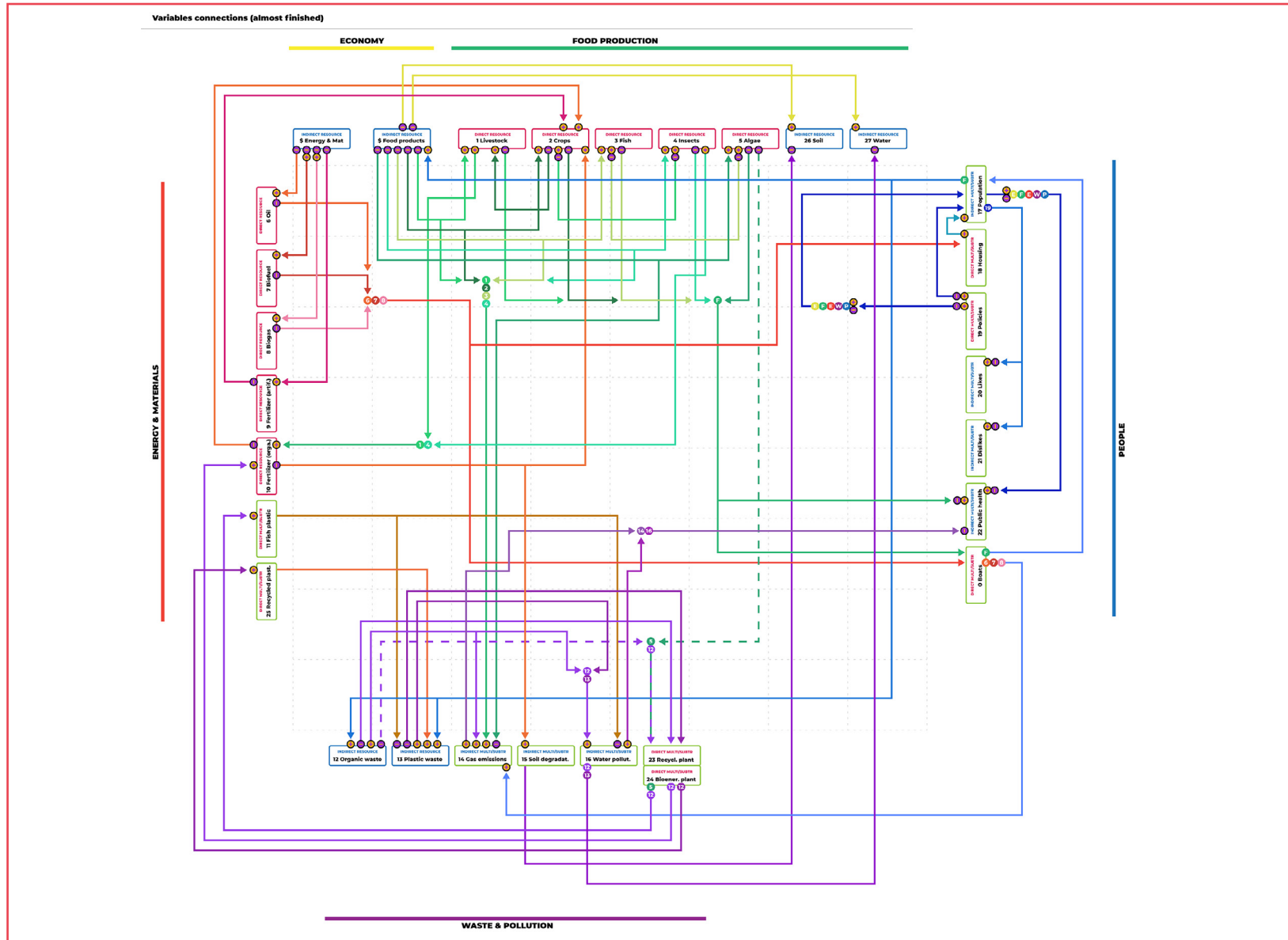

Game system spreadsheets

Initial costs.
Cost-benefits
of each
product in
the game in
a previous
prototype.

	Signs	Values	Req (\$)	Signs	Values	Req (Food)	Signs	Values	Req (Energy)	Signs	Values	Req (Waste)	Signs	Values	Req (Pollution)	Signs	Values	Req (Population)	Signs					
Food prods		<i>These relate to cost-benefit</i>	Bold means Auto.		<i>upg means "depends on upgrade". Goes from LO to HI.</i>	<i>Can be (res), or (mixed).</i>			<i>Can be (res) or (mixed)</i>			<i>Food does not affect waste manage</i>			<i>Pollution reduces approval, unless you push policies with certain marketing.</i>	<i>Population limit can be determined by migration policies?</i>		<i>Population is always producing pollution from consuming. Reduce it with policies.</i>						
ExportFood	Plus	upg	2, 1	resPas	Min	upg	2, 1	res*	Min	upg	2, 1	res			Plus	upg	2, 1	resPas	Plus/Min	slow	2, 1	resPas	Plus/Min	
Poultry01	Min	medlo	2, 2	resPas	Plus	lo	1, 1	mixed	Plus	lo	1, 1	mixed	Min	low	10, 2	res			Plus	lo	1, 1	resPas		Plus
Poultry02	Min	med	25, 45	resPas	Plus	med	25, 45	mixed	Min	low	10, 2	res			Plus	lomed	15, 17	resPas						Plus
Poultry03	Min	lo	100, 1	resPas	Plus	hi	300, 3	mixed	Min	hi	300, 3	res			Plus	hi	300, 3	resPas						Min
Cattle01	Min	medhi	45, 7	resPas	Plus	med	30, 5	mixed	Min	hi	60, 9	res			Plus	hi	60, 9	resPas						
Cattle02	Min	med	200, 2	resPas	Plus	hi	300, 3	mixed	Min	hihi	3, 2	res			Plus	hihi	300, 3	resPas						Min
Veggies01	Min	lo	1, 1	resPas	Plus	lo	1, 1	mixed	Min	med	2, 15	res			Plus	lo	1, 1	resPas						Plus
Veggies02	Min	med	25, 22	resPas	Plus	med	25, 22	mixed	Min	medhi	30, 28	res			Plus	lomed	15, 15	resPas						Plus
Veggies03	Min	lo	100, 1	resPas	Plus	hi	300, 3	mixed	Min	hi	300, 3	res			Plus	medhi	250, 25	resPas						Min
Fish01	Min	lo	1, 1	resPas	Plus	lo	1, 1	mixed	Min	med	2, 15	res			Plus	lo	1, 1	resPas						
Fish02	Min	med	25, 45	resPas	Plus	med	25, 45	mixed	Min	medhi	30, 5	res			Plus	med	25, 45	resPas						Plus
Fish03	Min	lo	100, 1	resPas	Plus	hi	300, 3	mixed	Min	hi	300, 3	res			Plus	hi	300, 3	resPas						Min
FishFarm01	Min	hi	50, 8	resPas	Plus	med	30, 5	mixed	Min	med	30, 5	res			Plus	med	30, 5	resPas						
FishFarm02	Min	med	200, 2	resPas	Plus	hi	300, 3	mixed	Min	medhi	250, 25	res			Plus	medhi	250, 25	resPas						Min
Micro01	Min	lo	1, 1	resPas	Plus	med	2, 15	mixed	Min	hi	3, 2	res			Min	lo	1, 1	resPas						Plus
Micro02	Min	medlo	20, 4	resPas	Plus	hi	35, 3	mixed	Min	hi	35, 3	res			Min	lo	10, 2	resPas						Plus
Micro03	Min	med	200, 2	resPas	Plus	hihi	350, 3, 2	mixed	Min	hi	300, 3	res			Min	lo	100, 1	resPas						Plus
MicroFert	Min	med	25, 45	resPas	Min	lo	10, 2		Plus	med	25, 45	res			Plus	lo	10, 2	resPas						Plus
WildAlgae01	Min	med	2, 15	resPas	Plus	lo	1, 1	mixed	Min	med	2, 15	res			Plus	medlo	1.5, 12	resPas						Plus
WildAlgae02	Min	medlo	20, 4	resPas	Plus	med	25, 45	mixed	Min	medhi	30, 28	res			Plus	medhi	30, 28	resPas						Plus
WildAlgae03	Min	lo	100, 1	resPas	Plus	hi	300, 3	mixed	Min	hi	300, 3	res			Plus	hi	300, 3	resPas						Min
AlgaeFarm01	Min	medhi	45, 7	resPas	Plus	med	30, 5	mixed	Min	med	30, 5	res			Min	lo	10, 2	resPas						Plus
AlgaeFarm02	Min	medlo	150, 1.5	resPas	Plus	hi	300, 3	mixed	Min	med	200, 2	res			Min	med	200, 2	resPas						Plus
Energy prods																								
ExportEnerg																								<i>Plus/Min means it can be changed by policy.</i>

Upgrade descriptions. Costs and effects of upgrades in a previous prototype.

#	VERBS	CONCEPT	OBJECT	EFFECT	NEWS POINTS	PREREQUISITE	COSTS
		Food: Cattle & Poultry					Fr
1	Unlock	Household chicken raising		New product			Cost
2	Unlock	Local chicken farm		New product			Cost
3	Unlock	Factory chicken farming		New product	- - - Diseases		Cost
4	Unlock	Cattle farming		New product			Cost
5	Unlock	Factory cattle farming		New product	- - - Protests		Cost
6	Administer	Genetic modifications	to cattle & poultry	Increase food yield, lower money cost			Cost
7	Purchase	Chicken coops	built from reused materials	Increase food yield, lower (energy cost) pollution	* Public Approval		Cost
8	Provide	A good cattle life	with open fields and care	Lower pollution emissions and people approve, but cattle is more expensive	* Public approval		Cost
9	Produce	Super-processed meat products		Highly lower costs of factory farming, highly increase food yield, pollution and energy costs	- Obesity		Cost
10	Implement	Sanitary protocols		Costs more money to produce food. Increases approval			
11	Administer	Antimicrobial drugs		Protect your livestock and/or poultry from diseases. (Increases the chance of viral mutations).		Factory chicken farming & Factory cattle farming	Cost
12		Agroecology: Cattle&Poultry and vegetables		Cattle&Poultry eat vegetables you have grown yourself. Increased food yield of community vegetable farm and cattle farming.	* Local growth	Community vegetable farm & Cattle farming	Just prerequisites
1	Pass	Policy: Red meat marketing	food exportation	Increase income, pollution and approval	Diet article	household poultry, local poultry, factory poultry, factory cattle. (Local cattle does not receive approval, but does receive money boost)	Cost

Cataclysm system configuration



Deceased cattle
▼

Epidemic spreads
▼

Green call for action
▼

Gtonnes of GHG
▼

Regional hunger
▼

Oil war
▼

Barren farm lands
▼

Energy crisis
▼

Regional energy industry faces the possibility of bankruptcy, dragging other industries with it.

Plastic landfills pile up
▼

Climate change protests
▼

TITLE	COPY	CONDITION	OUTCOME	SOLUTION
CONTINGENCIES				
Deceased cattle	Number of sick cattle increases. Low health conditions in factory farms may be the cause. Animal protection protests ensue.	Food is high. Factory cattle farming is high.	Approval falls. Food falls.	Approval falls.
Epidemic spreads	Confirmed cases increase. Experts believe source to be factory chicken farms.	Food is high. Factory chicken farming is high.	Approval falls. Food falls.	Approval falls.
Green call for action	Marine life affected by intensive fishing. Activists organize protests and boycotts.	Food is high. Commercial fishing is high. Pollution is high.	Approval falls (protests). Economy falls.	Approval falls.
Gtonnes of GHG	Landfills with food waste have increased dramatically. Over 4 giga tonnes of GHG emissions produced globally last year.	Condition: Food reaches a very high level, population is not high enough.	Pollution scales. Approval falls (protests).	Pollution scales.
Regional hunger	Hunger levels rise as food supplies have plummeted in the last months. Society in disarray.	Condition: Food reaches a very low level.	Economy falls. Population falls.	Economy falls.
Oil war	Opposing energy world powers drop oil barrel price to the floor. Regional oil economy suffers as high production costs create a sinking deficit.	Condition: Energy level is very high and its main component is oil barrels.	Oil production gets more expensive and the gains are too low.	Oil production gains are too low.
Barren lands	Farming soil has degraded considerable. Geologists say artificial fertilizer could have been one of the main factors.	Condition: Artificial fertilizer and energy too high	Vegetable production produces less food.	Vegetable production produces less food.
Energy crisis	Regional energy industry faces bankruptcy.			
Plastic landfills pile up	"As plastics are recycled, it becomes more difficult to process them", says expert. Waste ends up in landfills.	Condition: Waste management and recycled waste too high.	Pollution scales and it costs more energy to recycle	Pollution scales and it costs more energy to recycle
Climate change protests	Massive number of citizens plan on boycotting fossil-fuel products, due to uncontrolled levels of greenhouse gas emissions.	Pollution is high and waste m. is low.	Approval falls. Economy falls. Energy falls.	Approval falls.

News and cataclysms. Cataclysms have different effects in the system.

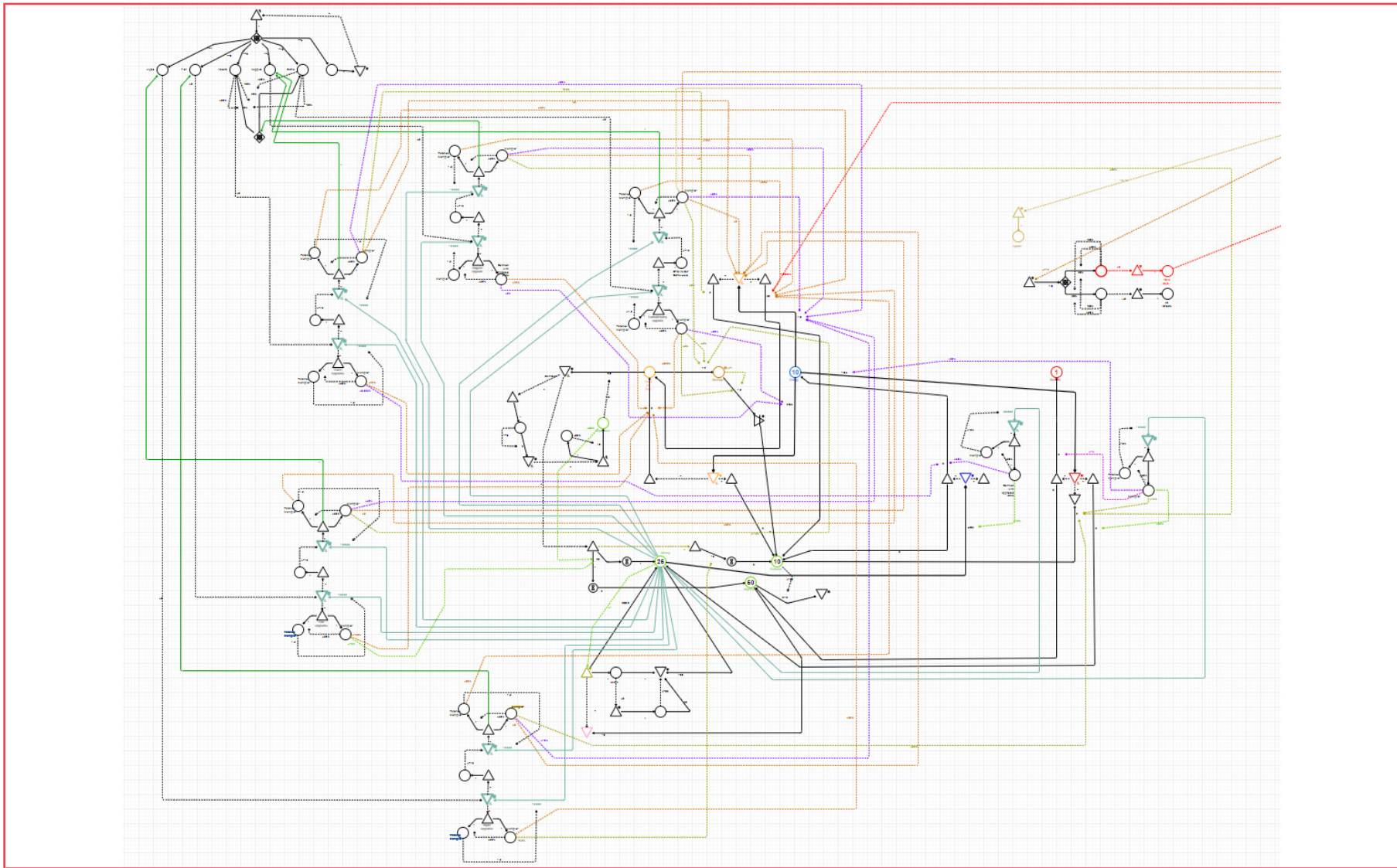

Simulation diagram. Deeper implementation of the core loop, by-products, upgrades, and cataclysms.

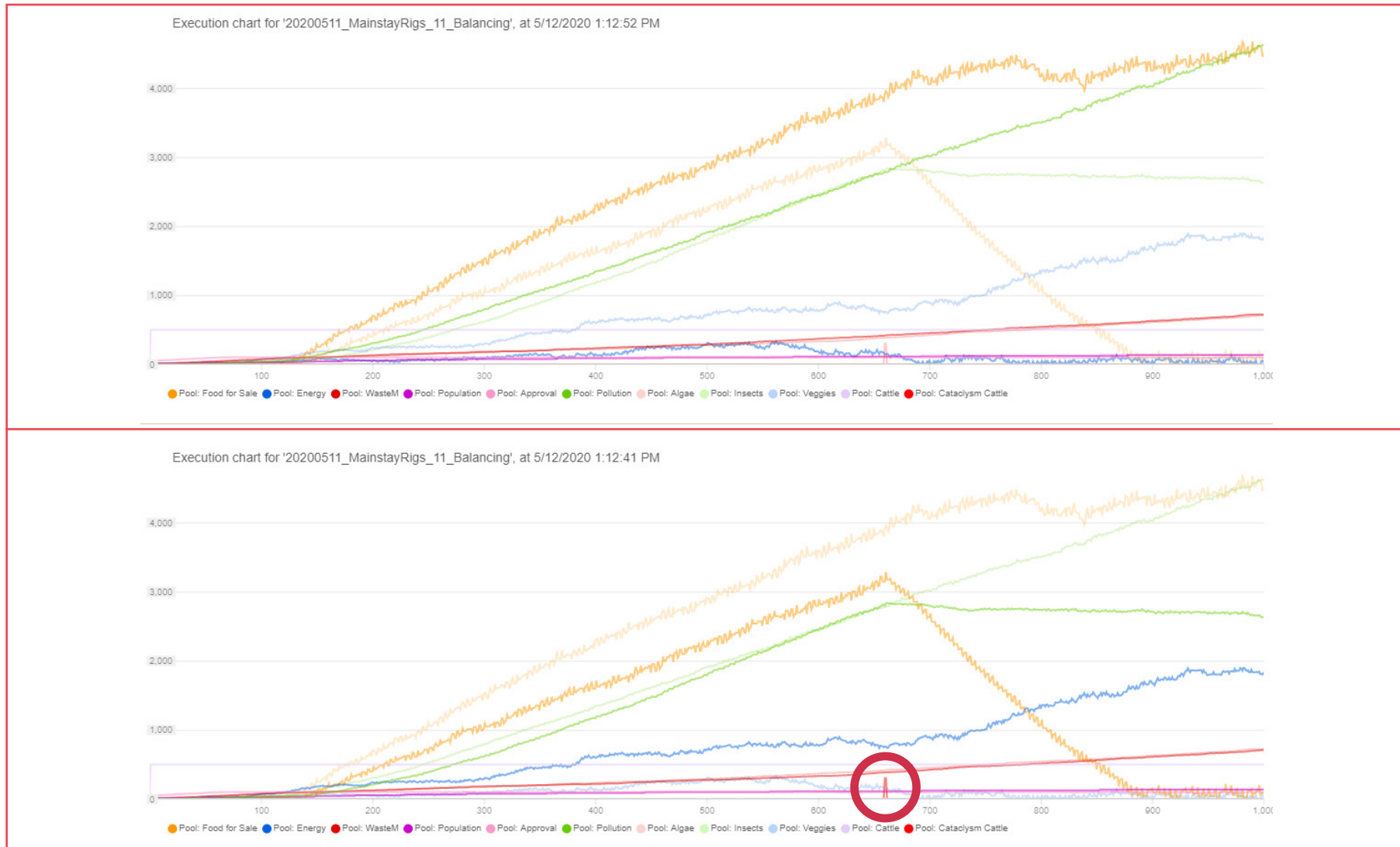

Machinations graphs and cataclysms. The flow of resources can be visualized during run-time in Machinations. The graph above highlights a run where there was no cataclysms, and food production (the yellow-orange line) continued increasing. The lower graph shows a cataclysm, where food production drastically fell. The “cataclysm spike” is highlighted with a circle.

Logo and naming iterations

MAINSTAY
RIGS

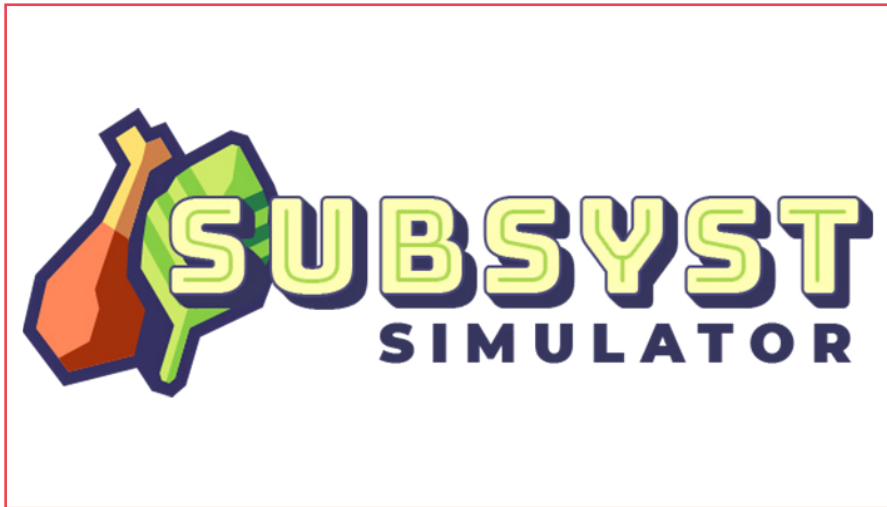

First round of playtests

Mainstay Rigs

Questionnaire

Thank you for playing Mainstay Rigs. I appreciate your time to answer this questionnaire, which should take you between 5 to 10 minutes. Your comments are very valuable and will help me to improve the game.

1. What was your first impression of the game?

a. Answer.

2. Was there anything you found frustrating?

a. Answer.

3. Were there particular aspects that you found satisfying?

a. Answer.

4. What would you say is the main objective to get in the game?

a. Answer.

5. What kind of decisions did you make as you played?

a. Answer.

6. What elements could be improved?

a. Answer.

7. Was it easy to understand the rules of the game?

a. Answer.

8. Was it easy to find the information that you needed?

a. Answer.

9. Was there any element that was clunky, awkward or confusing?

a. Answer.

10. Mention one element that you would change/remove/add to the game.

a. Answer.

Assessment results

The results can also be found in the following link:

Assessment results charts

<https://docs.google.com/presentation/d/1l4HjFbNraUNq16ktupTLetm6FWsnOaiRsX-G0hUwlbM/edit?usp=sharing>



Thank you for answering the questionnaire last time.

I want to present to you the **SUBSYST Simulator**. It is a game which takes you through the experience of being a food producer and securing food for a city.

I would like to invite you to test the game. The test would consist of two parts: playing the game and then answering a final questionnaire.

For the first part, I would kindly ask you to play the game for a minimum of **30 minutes**. In this way, you can become familiarized with the controls, the rules and the content of the game. You can of course play for a longer period of time, if you like. If possible, I would kindly ask you to play the game before the 30th of May.

The game can only be played online, in a computer browser. You can find the game in the following link:

<https://eplundare.itch.io/subsyst-simulator>

The final part of the test involves a **second questionnaire**. I will share it with you one day after the game session. Therefore, I would kindly ask you to notify me, once you've played the game.

I would deeply appreciate your help. If you would like to participate in the test, please send me a 👍 in a message through Facebook.

If you have any questions, feel free to send me a message. Your participation will be very meaningful for the project.

Yours sincerely,

Alexis Emmanuel Lozano Angulo
aelozanoa@gmail.com

Test invitation.

How to read the results 1/5

Before and after

Please select one or more food productions that you think are benefiting the environment.
8 responses

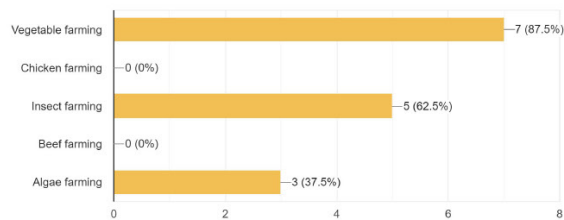

Please select one or more food productions that you think are benefiting the environment.
8 responses

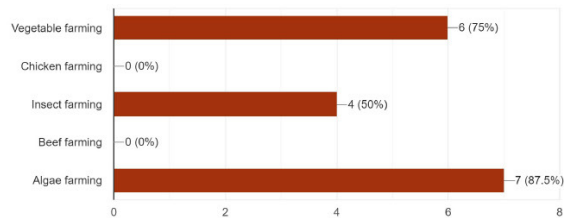

Example results

Each question presents two sets of results: a **before** (first questionnaire) and **after** (second questionnaire).

The results in the **upper half** of the slide refer to the results of the **first questionnaire**. One day later, participants played the game *SUBSYST Simulator*.

One day after playing, participants answered the **second questionnaire**. Its results are in the **lower half** section of the slide.

The test involved **eight (8) participants** in total.

How to read the results 2/5

Example results

The results of the **second questionnaire** will have the following annotations:

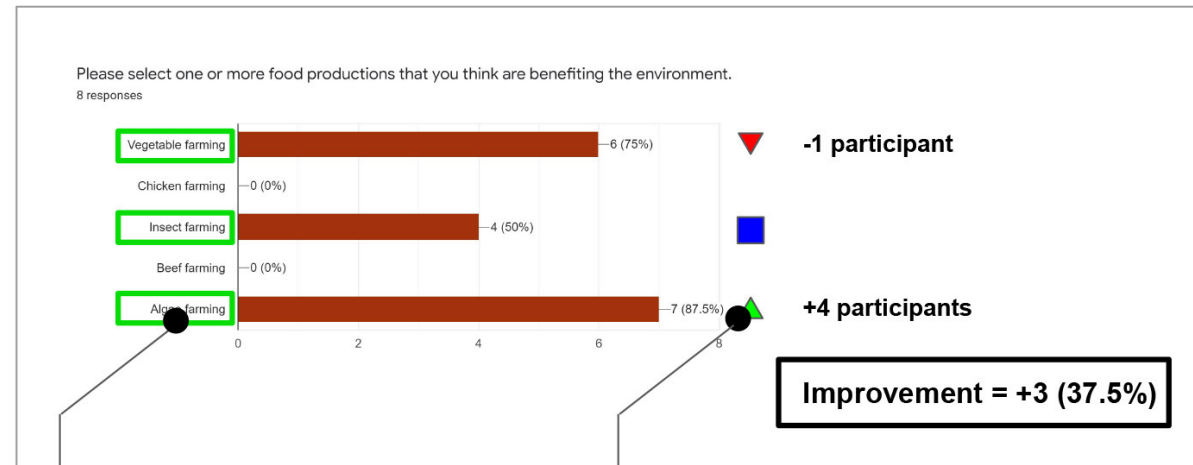

Options enclosed in a green rectangle are the right answers.

A green triangle (▲) signifies improvement, compared to the first questionnaire. A red triangle (▼) signifies a decrease in improvement. A square (■) signifies that nothing changed.

How to read the results 3/5

Symbols

These symbols are only used to analyse the results of the **correct options.**

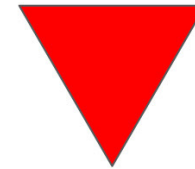
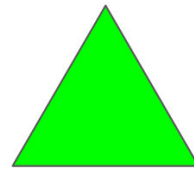

How to read the results 4/5

Total improvement

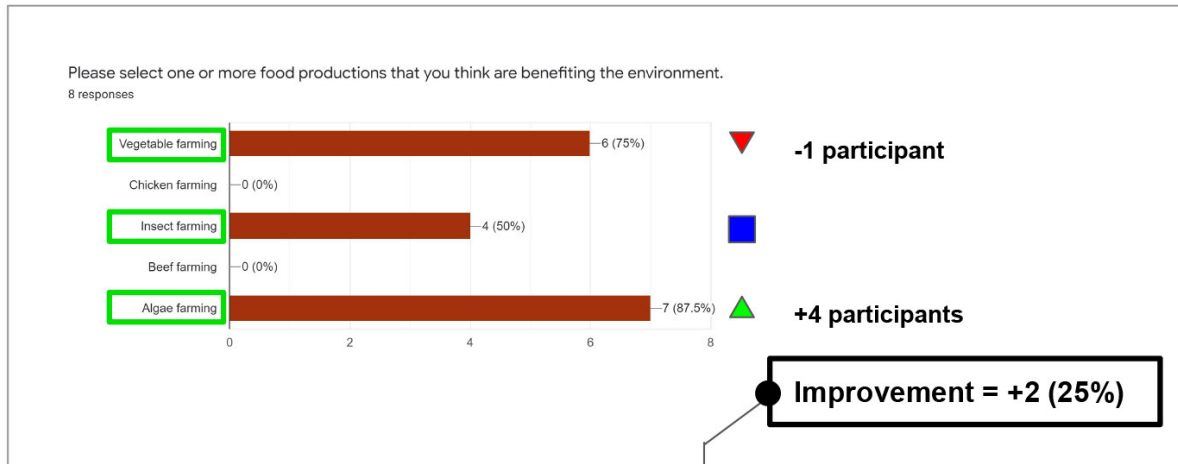

Information enclosed in a black rectangle contains the total improvement of correct answers, compared to the first questionnaire.

How to read the results 5/5

Improvement points

At the start of each questionnaire section, and after the end of the three main sections, it is possible to find the **improvement results**.

In the example to the right, only one participant chose the right answer (Recycling plastic) in the first questionnaire. Five more participants chose that option, in the second questionnaire. Thus, there were a total of **5 improvement points**.

One **improvement point** refers to the increase of one participant who chose one correct option in the second questionnaire, in contrast to the first questionnaire.

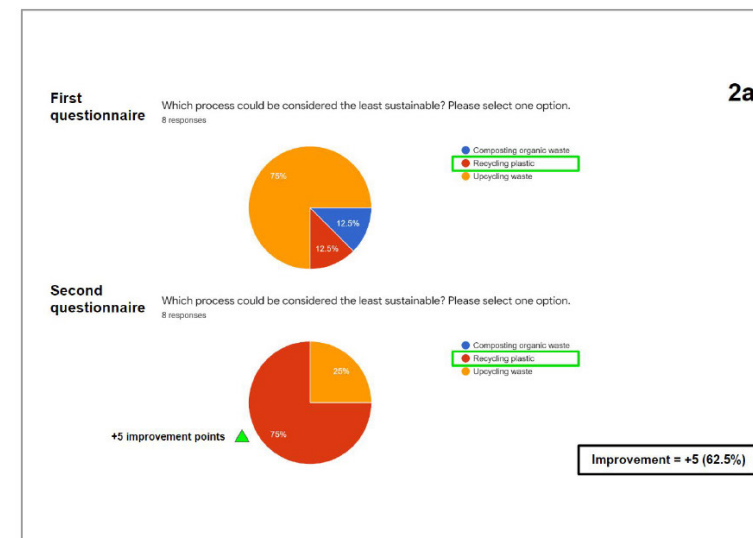

Sustainability

Number of questions in this section:
5 questions

Average improvement of this section:
+1.8 improvement points

There was a **22.5% increase** of
improved knowledge, in average

1a

First questionnaire

Please select one or more food productions that you think are benefiting the environment.

8 responses

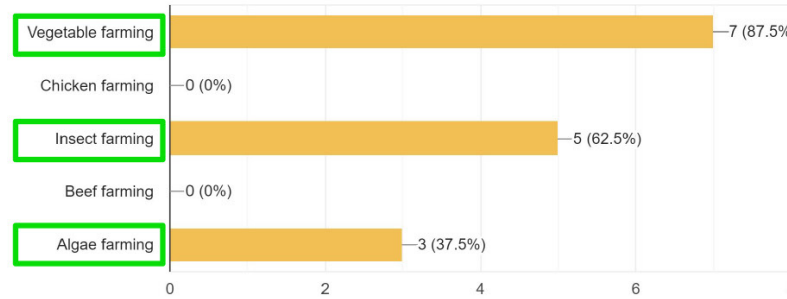

Second questionnaire

Please select one or more food productions that you think are benefiting the environment.

8 responses

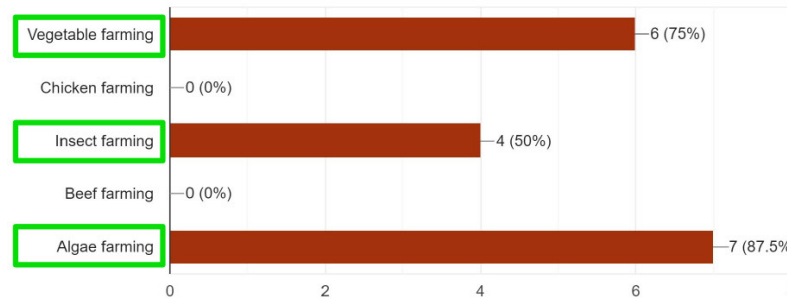

▼ -1 improvement point

▼ -1 improvement point

▲ +4 improvement points

Improvement = +2 (25%)

2a

First questionnaire

Which process could be considered the least sustainable? Please select one option.
8 responses

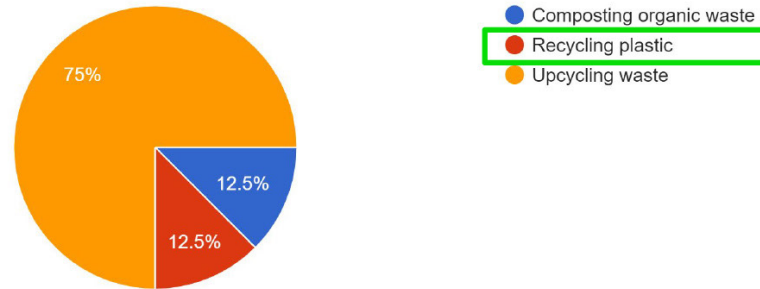

Second questionnaire

Which process could be considered the least sustainable? Please select one option.
8 responses

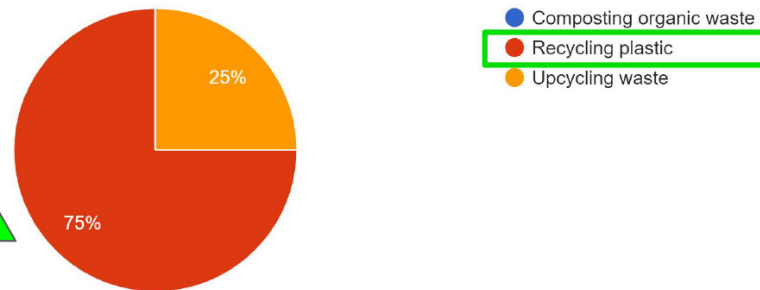

+5 improvement points ▲

Improvement = +5 (62.5%)

3a

First questionnaire

Which of the following resources can be used to produce energy? You can select one or more options.
8 responses

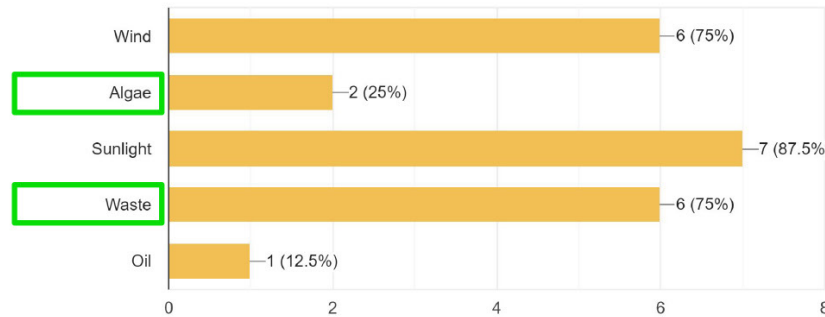

Second questionnaire

8 responses

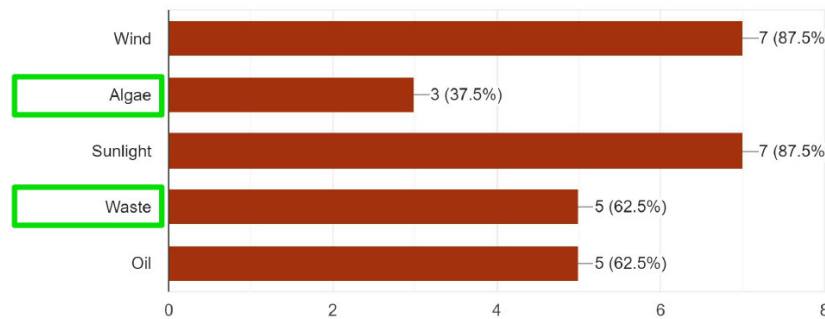

▲ +1 improvement point

▼ -1 improvement point

Improvement = 0 (0%)

4a

First questionnaire

What use does fish waste have? Please select one option.
8 responses

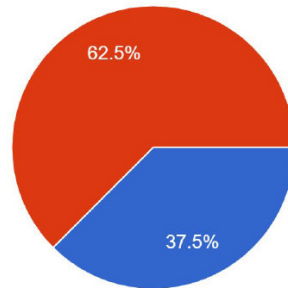

- It can be upcycled with red algae to produce a biodegradable plastic
- It can be synthesized to produce organic fertilizer and compost
- It can be processed to create building and housing materials

Second questionnaire

What use does fish waste have? Please select one option.
8 responses

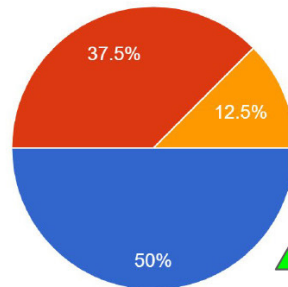

- It can be upcycled with red algae to produce a biodegradable plastic
- It can be synthesized to produce organic fertilizer and compost
- It can be processed to create building and housing materials

▲ +1 improvement point

Improvement = +1 (12.5%)

5a

First questionnaire

Can cities rely on recycling plastic in the long term? Please select one option.
8 responses

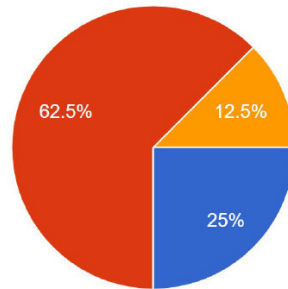

- Yes, because in that way there's a lesser need to produce new plastic
- No, because unclean mixed plastics require more resources for processing
- Yes, because it prevents the emission of more greenhouse gases in the environment
- No, because new plastics need to be produced, after all

Second questionnaire

Can cities rely on recycling plastic in the long term? Please select one option.
8 responses

+1 improvement point ▲

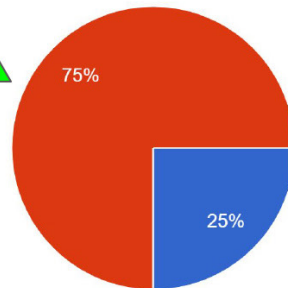

- Yes, because in that way there's a lesser need to produce new plastic
- No, because unclean mixed plastics require more resources for processing
- Yes, because it prevents the emission of more greenhouse gases in the environment
- No, because new plastics need to be produced, after all

Improvement = +1 (12.5%)

Food, energy and waste

Number of questions in this section:
4 questions

Average improvement of this section:
+4.5 improvement points

There was a **56.25% increase** of
improved knowledge, in average

1b

First questionnaire

Which option requires the most energy to produce and also pollutes the most? Please select one option.

8 responses

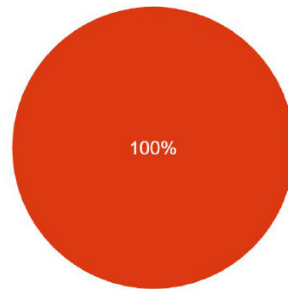

- Vegetables and grains
- Beef meat and dairy
- Chicken meat and eggs
- Algae protein
- Insects

Second questionnaire

8 responses

0 improvement points

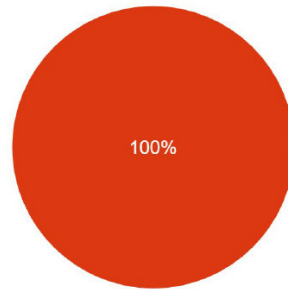

- Vegetables and grains
- Beef meat and dairy
- Chicken meat and eggs
- Algae protein
- Insects

Improvement = 0 (0%)

2b

First questionnaire

Which food production(s) could reduce an amount of greenhouse gases or waste from the environment? Please select one or more options.

8 responses

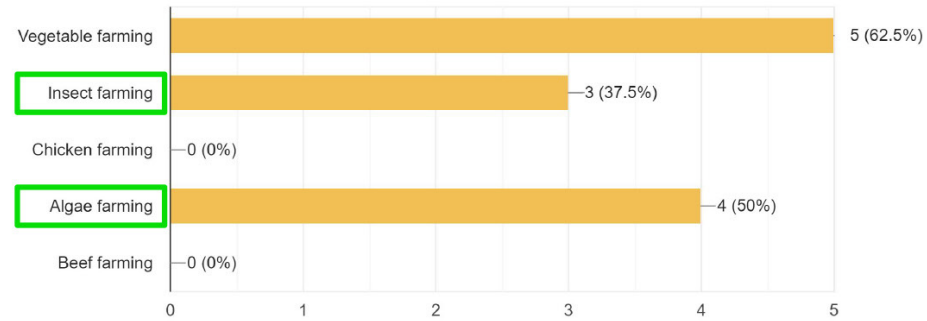

Second questionnaire

8 responses

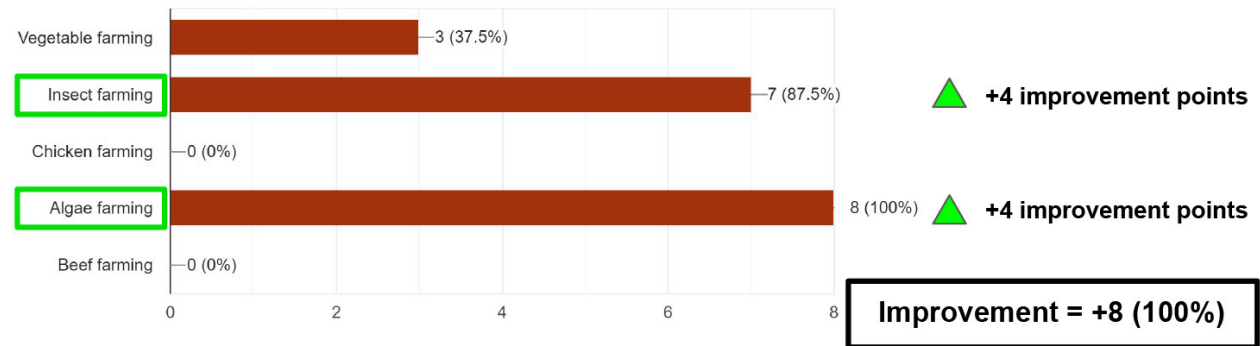

3b

First questionnaire

What aspects could be linked to the use of artificial fertilizers for growing crops? You can choose one or more options.
8 responses

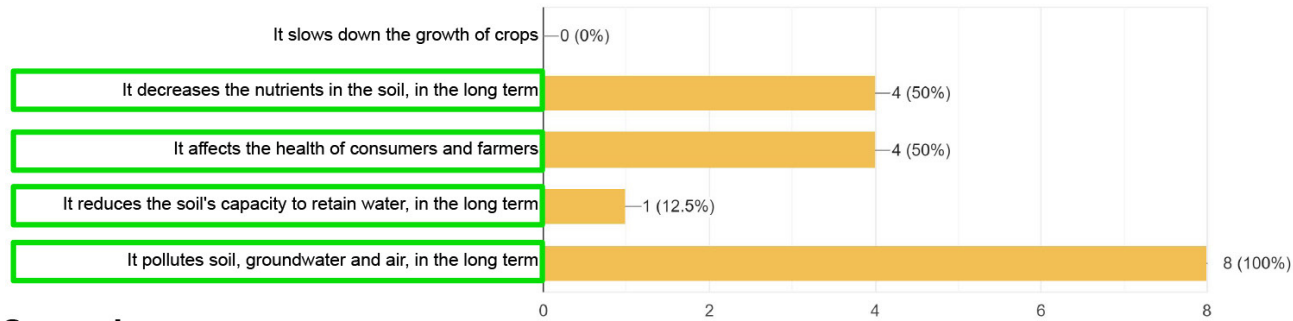

Second questionnaire

8 responses

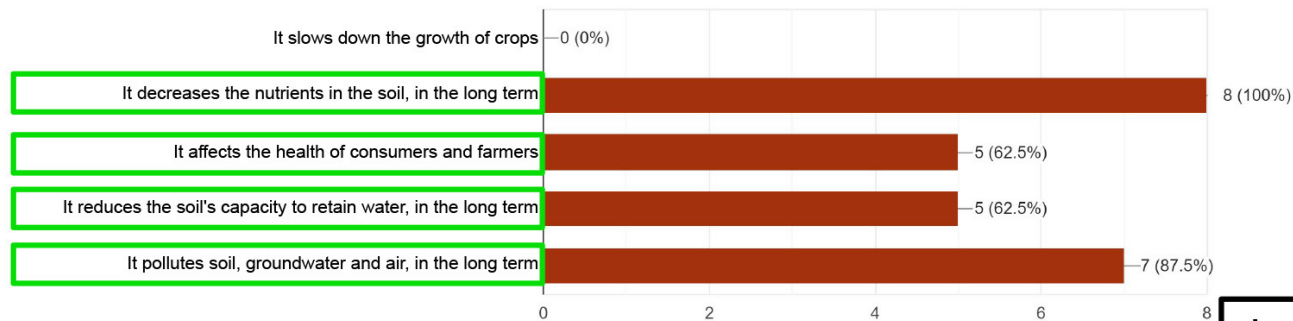

- ▲ +4 improvement points
- ▲ +1 improvement point
- ▲ +4 improvement points
- ▼ -1 improvement point

Improvement = +8 (100%)

4b

First questionnaire

In your opinion, which food productions are beneficial for societies, the economy and the environment in the long-term? Please select one or more options.

8 responses

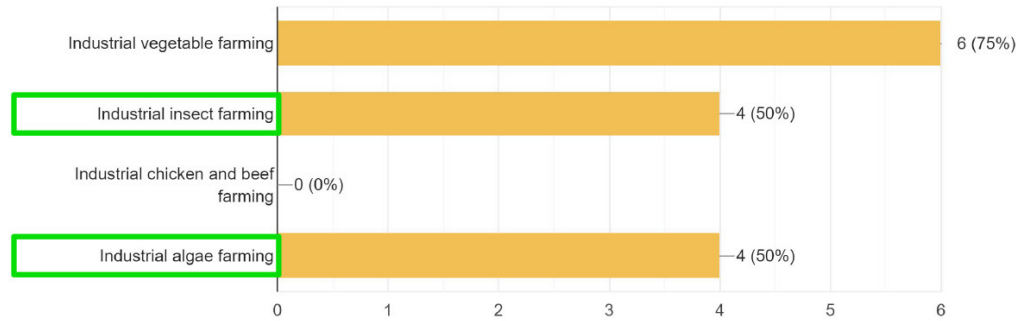

Second questionnaire

8 responses

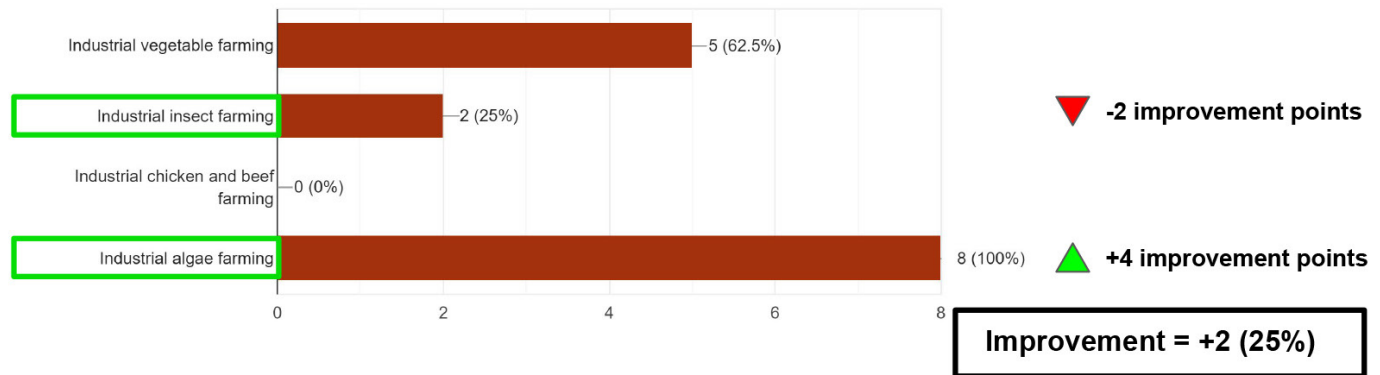

Sustainable food production

Number of questions in this section:
2 questions

Average improvement of this section:
0 improvement points

There was a **0%** of improved knowledge,
in average

1c

First questionnaire

How could beef production become more sustainable? Please select one option.
8 responses

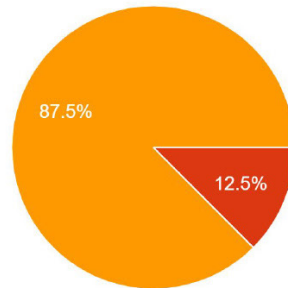

- Immunize cattle to prevent diseases inside industrial farms
- Increase the amount of food produced by industrial farms
- Use organic waste from crops to feed cattle

Second questionnaire

How could beef production become more sustainable? Please select one option.
8 responses

-1 improvement point ▼

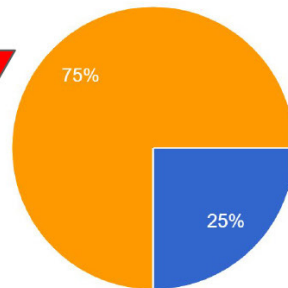

- Immunize cattle to prevent diseases inside industrial farms
- Increase the amount of food produced by industrial farms
- Use organic waste from crops to feed cattle

Improvement = -1 (-12.5%)

2c

First questionnaire

How could vegetable and crop productions become more sustainable? Please choose one option.
8 responses

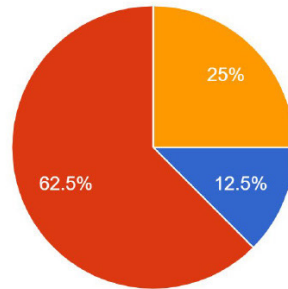

- Employ artificial fertilizers to secure the rapid growth of crops
- Besides crops, breed cattle and use its manure to fertilize farming soil
- Create more industrial farms in order to provide more food to the population

Second questionnaire

How could vegetable and crop productions become more sustainable? Please choose one option.
8 responses

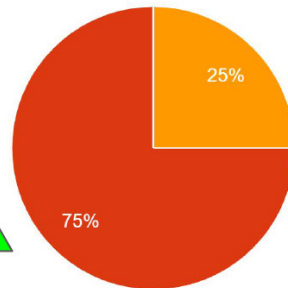

- Employ artificial fertilizers to secure the rapid growth of crops
- Besides crops, breed cattle and use its manure to fertilize farming soil
- Create more industrial farms in order to provide more food to the population

+1 improvement point ▲

Improvement = +1 (12.5%)

Full test results

Total number of assessed questions:
11 questions

Average improvement in total:
+2.45 improvement points

There was a **30.6% increase** of
improved knowledge, in average

Other questions: Society

First questionnaire

Who has the most important role in developing more sustainable economies and societies? Please choose one option.

8 responses

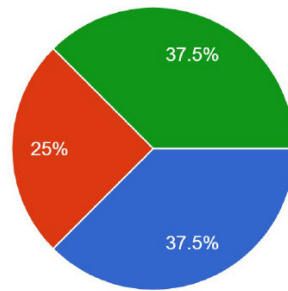

- Governments
- Farmers and producers
- Retail stores
- Buyers and consumers
- Educational institutions

Second questionnaire

8 responses

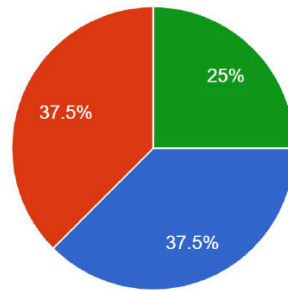

- Governments
- Farmers and producers
- Retail stores
- Buyers and consumers
- Educational institutions

First questionnaire

What could citizens do to help the environment? You can choose one or more options.

8 responses

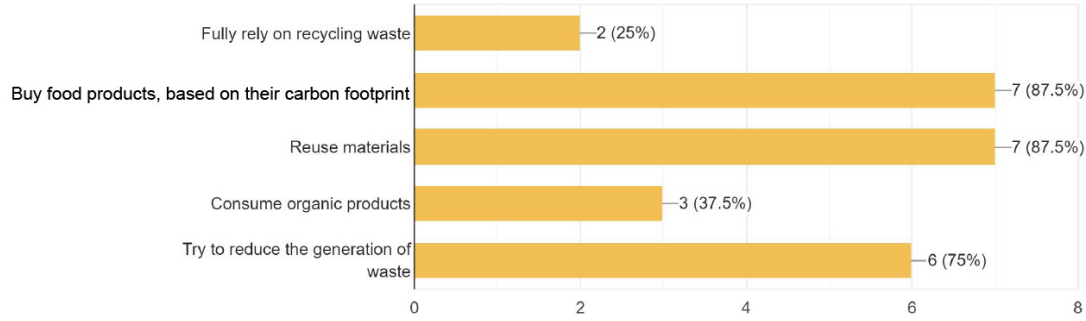

Second questionnaire



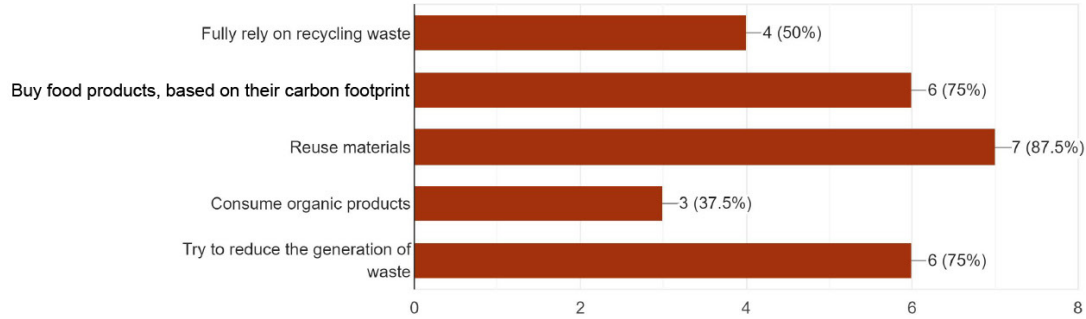

8 responses



First questionnaire



(Optional) In your opinion, how could cities achieve a balance between food production, consumption and their impact on the environment? Please write between 3 to 5 lines.³

responses

- Participant A*  • Buying an amount of food that you are able to eat to prevent wasting food. I think the lies in the amount of food wasted due to people enormous groceries shopping habbits [sic] and thus not being capable of eating all the food before expiring.
- Participant B*  • That is a very hard question, and sadly I have no clue..
- Participant C*  • They could take other countries' traditional way of farming and try to make it happen in their own countries, as long as their weather and soils are similar. Tradition is almost always right, the people who work the land have known it for centuries.
- Participant D*  • I think the only way to achieve a balance between food and production is trying to eat less meat and try to avoid drinking milk, since meat is the principal source of production of carbon dioxide emissions. Also it consumes a lot of water and it need a lot of seeds in order to make the animals grow. When we start eating less meat (like just eat meat in 1 day from the 7 days of the week), the demand for this kind of products will be reduced and this will reduce all the damages to the nature that it produces nowadays.
- Participant E*  • By switching industrial farming to plant-based! Considering that most of the land we use to grow crops are used to feed the animals in animal agriculture (56 billion a year), switching to plant-based would mean less land use and fewer emissions!

Second questionnaire

(Optional) In your opinion, how could cities achieve a balance between food production, consumption and their impact on the environment? Please write between 3 to 5 lines.³ responses

- Participant C*  • The people can have a strong desire and will to stop the environment from becoming sterile, but in the end, the government is responsible for what changes are done and how these changes will affect the future, so it's not all about our habits, it's about these habits being reinforced and instituted by the government.
- Participant D*  • Since the nature give us all the resources we need to survive, we can achieve sustainability [sic] by seeking the ways to reduce the production of waste like producing insect farming that can help reduce the waste of the meat production.

Other questions: Gaming habits

First questionnaire

I would like to know in what gender do you identify yourself. Please select one of the following options.

8 responses

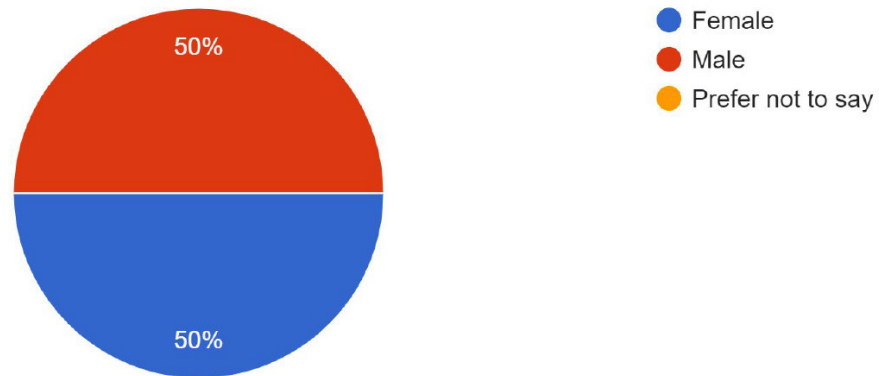

First questionnaire

I would like to know what is your age. Please select one of the following age ranges.

8 responses

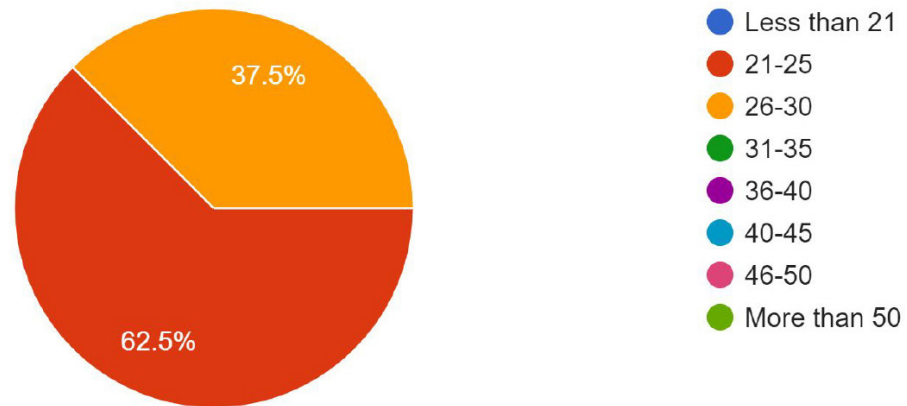

First questionnaire

How frequently do you play board games or video games?

8 responses

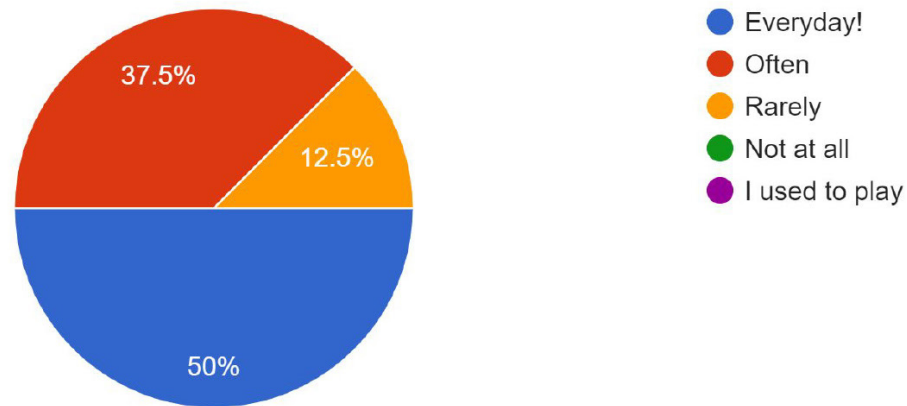

First questionnaire

In which platform(s) do or did you usually play? Please select one or more options.

8 responses

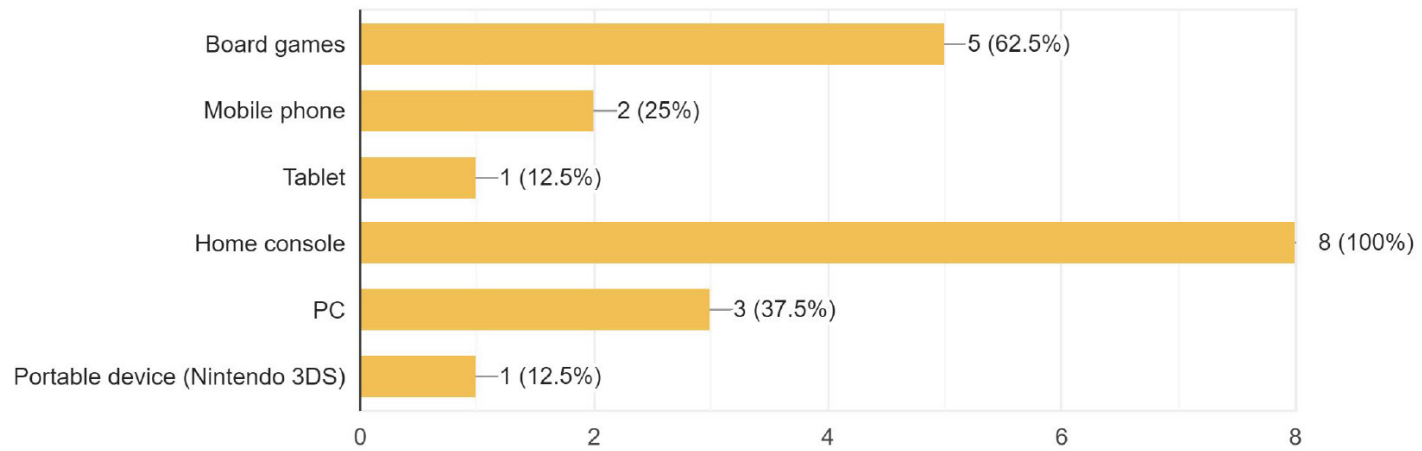

First questionnaire

What kind of games do you like to play? You can select one or more options.

8 responses

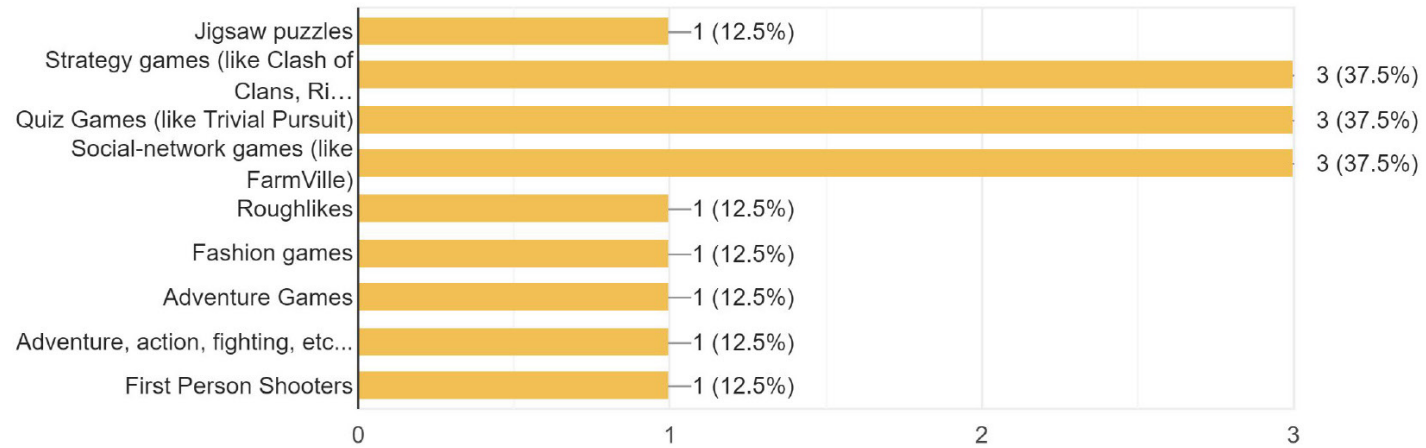

Other questions: Gameplay session

Second questionnaire

Approximately, how long did you play the SUBSYST Simulator? Please select one of the following time ranges.

8 responses



Second questionnaire

From 1 to 5, please tell me the level of investment that you gave to each food product. 1 means "I did not invest in this product, at all", while 5 means "I intensely invested in this product".

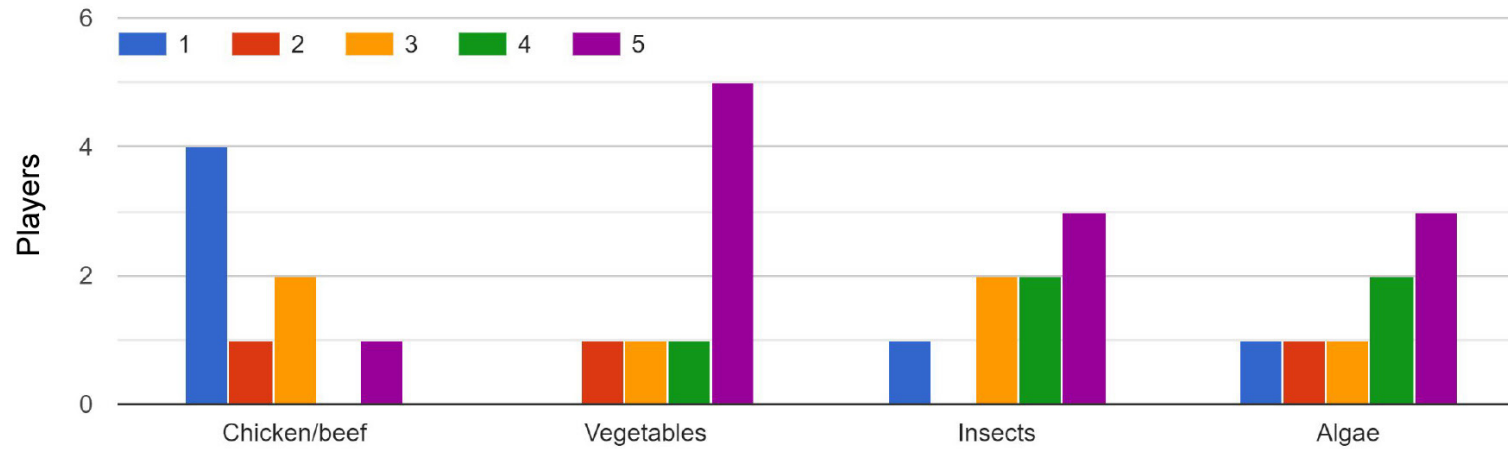

Second questionnaire

In case you invested less resources in a specific food product, what was the reason behind this decision? If your investments were similar between...e skip this question and continue to the next one.

8 responses

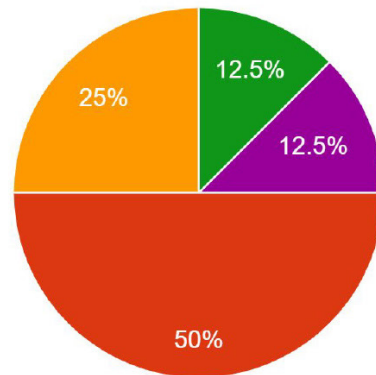

- I never thought about producing other kind of food.
- The cost-benefits of this product did not seem useful.
- Some events in the game made me focus on another product.
- I produced these other product, but with a medium intensity.
- experimented wiht only one type of food each run

Second questionnaire

In the energy station, did you change the oil production for biogas production?

8 responses

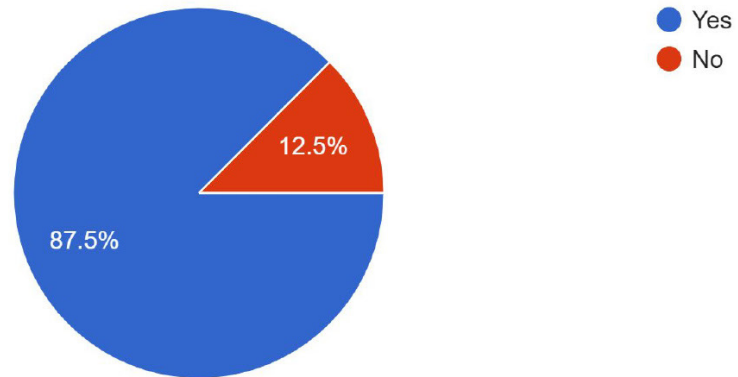

Second questionnaire

From 1 to 5, please tell me the level of investment that you gave to each waste management process. 1 means "I did not invest in this process, a...hile 5 means "I intensely invested in this process".

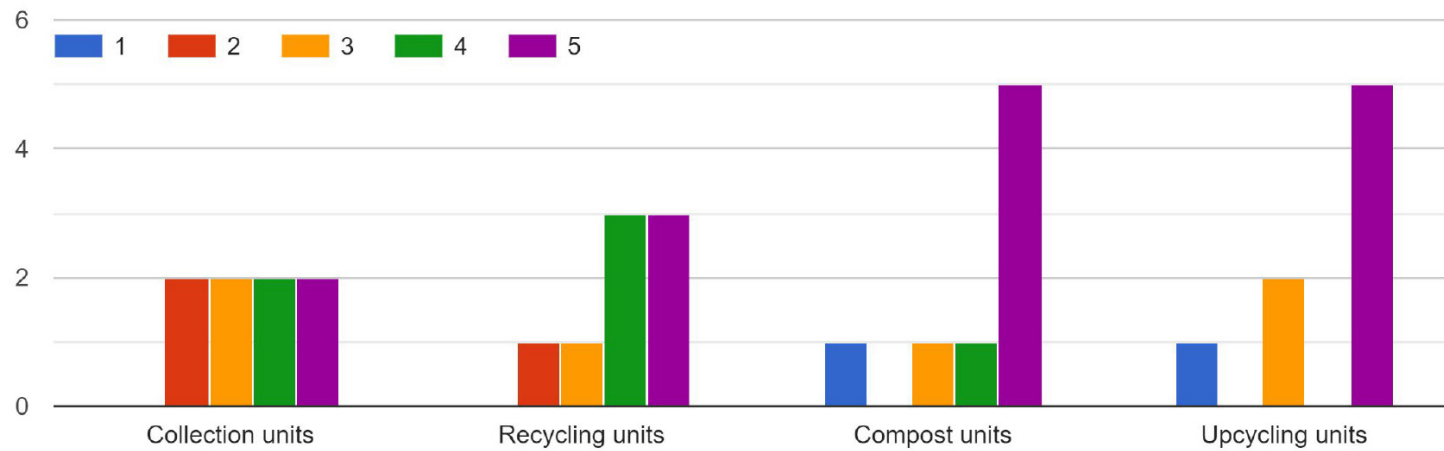

Second questionnaire

In case you invested less resources in a specific waste management process, what was the reason behind this decision? If your investments were simi...e skip this question and continue to the next one.

8 responses

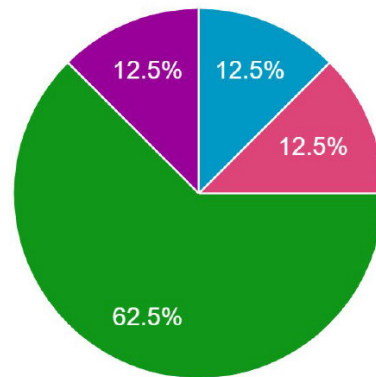

- I never thought about using another waste management process.
- The resources it processed were too little.
- Some events in the game made me focus on another waste management...
- I used these other methods, but with a...
- They were the same
- I invested in all with about the same in...
- recycling was mostly a part of the strat...

Second questionnaire

Which events happened during your gaming session? Please select one or more options.

8 responses

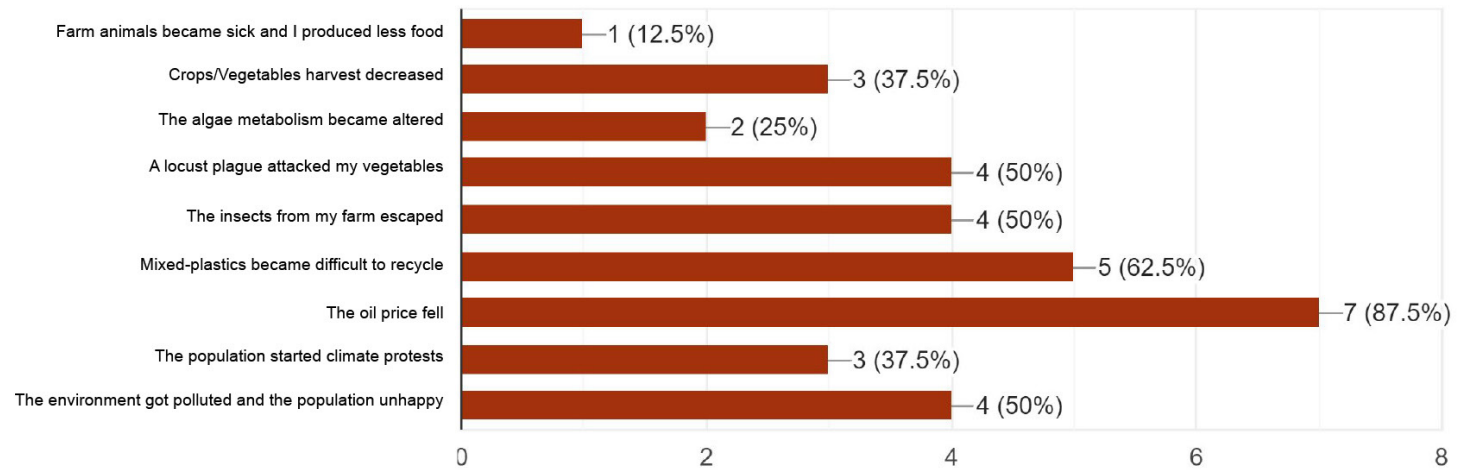

Current prototype



Start screen.



Tutorial.



Food station.



Game map.



Energy upgrades.



The Sower Online, local newspaper.

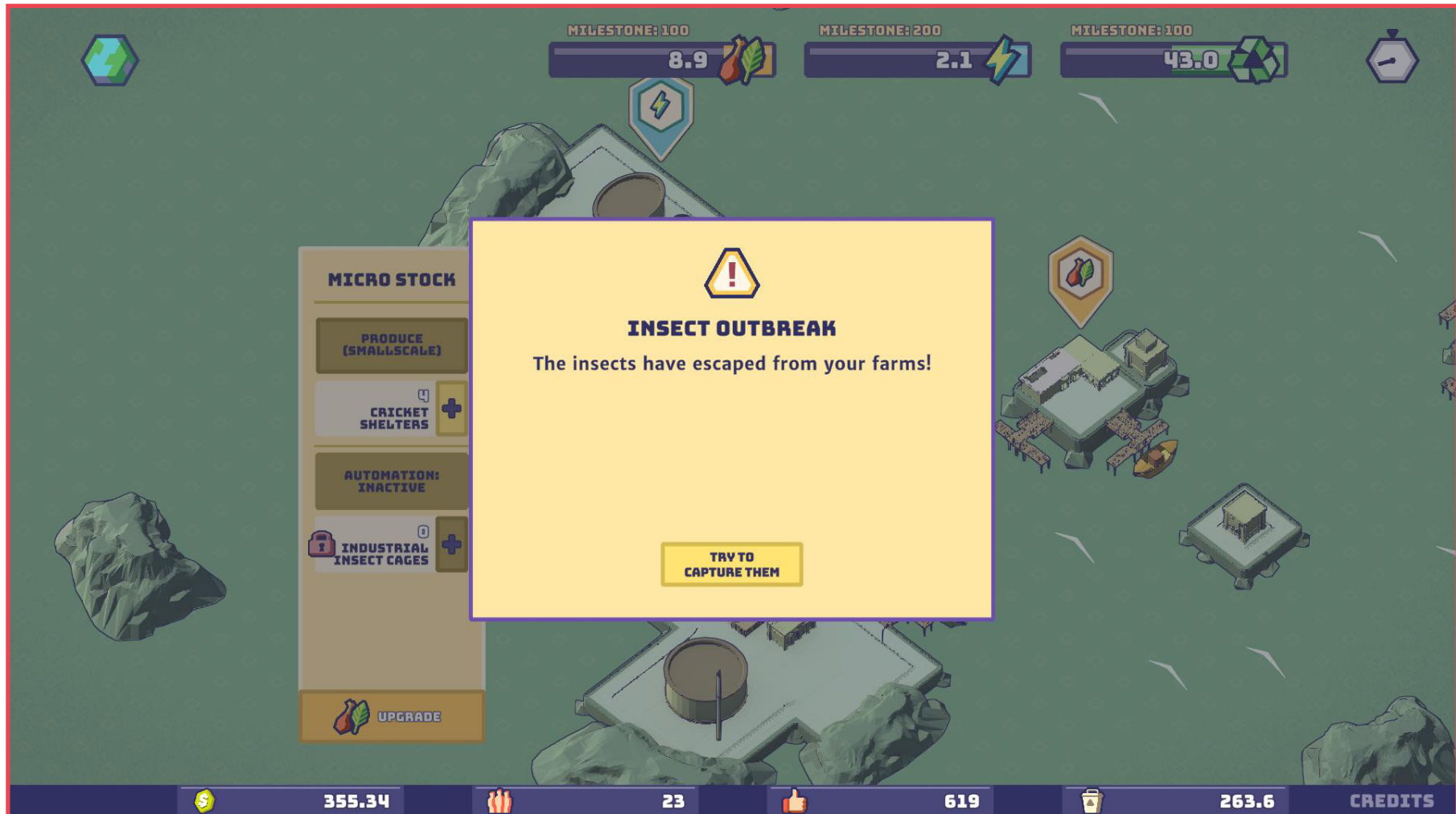

Possible cataclysm about to happen.

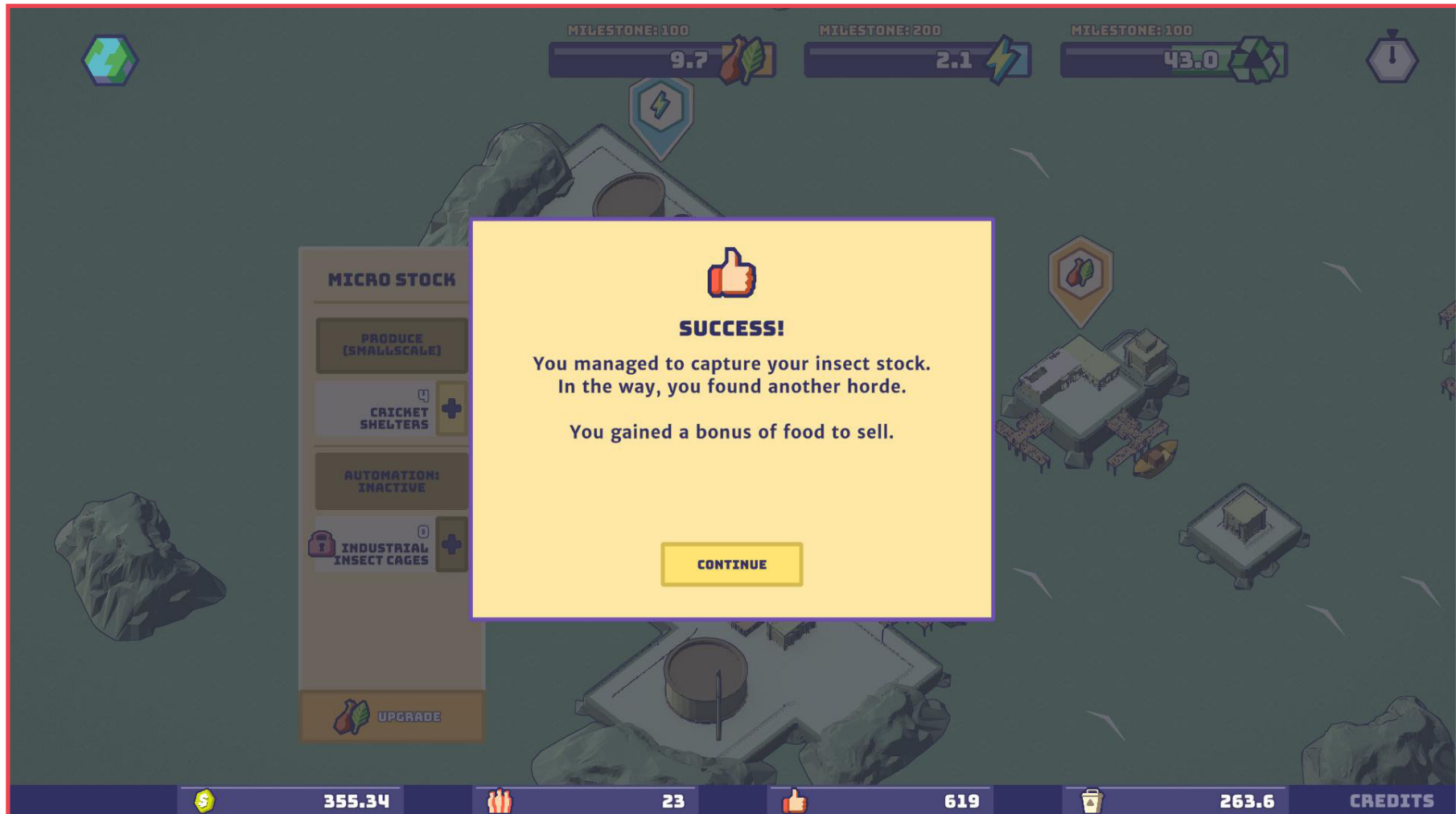

Sometimes cataclysms do not occur.

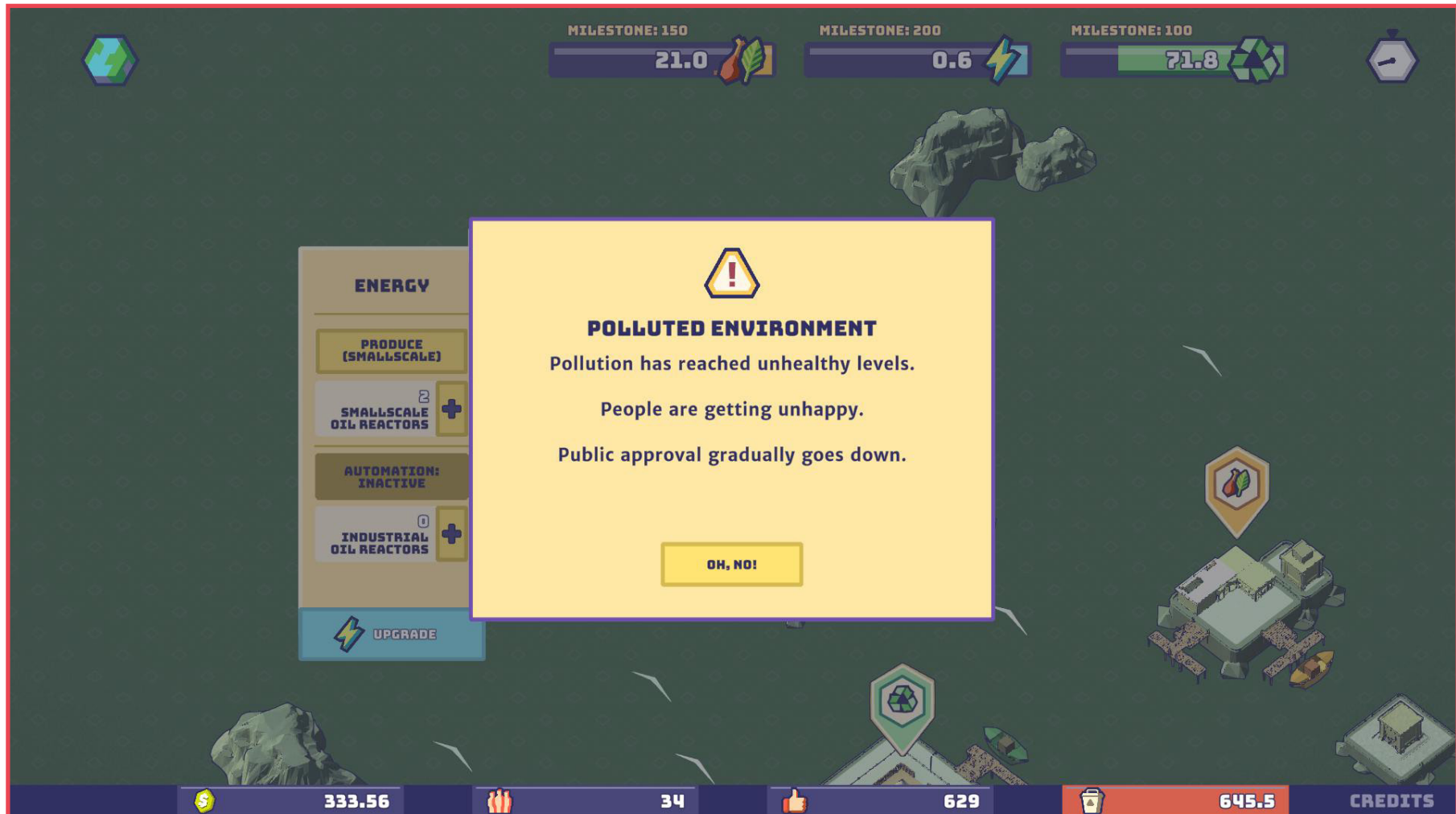

Mild cataclysm.



Credits and resources

The 3d models used in the game, as of June 4th, are from the Polygon Game Dev Humble Bundle, by Synty Studios. Michael R. Schmidt provided technical support and advice related to the tech-art (outline for 3d objects and color blending system) and programming (game economy system). The outline shader was designed by Erik Roystan Ross, and downloaded from his website: <https://roystan.net/articles/outline-shader.html>

Most animations in the game are handled using LeanTween by Dented Pixel, acquired from the Unity Asset Store. The camera mouse-drag and other UI functionalities were scripted based on code from different Unity Forums and Unity Answers users, such as jashan, AP124526435, and manutoo.

“Fiesty and Tacky” was composed by Blue Dot Sessions. It is licensed under an Attribution-NonCommercial License. The track was edited, adding fade-outs and fade-ins. Licence link: <https://creativecommons.org/licenses/by-nc/4.0/>

“Ambience, Seaside Waves, Close, A.wav” was mixed by InspectorJ (www.jshaw.co.uk) of Freesound.org. The track was edited, adding fade-outs and fade-ins. Licence link: <https://creativecommons.org/licenses/by/3.0/>

“Pen_click_3.wav” was recorded by Adam_N of Freesound.org. “Cash Register Purchase” was mixed by Zott820 of Freesound.org.



Game theory and practice references

- 1 Brignull, H., Darlington, A., 2010. TYPES OF DARK PATTERN. Published online at www.darkpatterns.org. Retrieved from: '<https://www.darkpatterns.org/types-of-dark-pattern>' [Online Resource]
- 2 Culyba, S., 2018. The Transformational Framework: A process tool for the development of Transformational games. ETC Press.
- 3 Grace, L. 2011. Discomfort Design: Critical Reflection through Uncomfortable Play, 17th International Symposium on Electronic Art (ISEA), Istanbul, Turkey. Retrieved from: 'http://www.professorgrace.com/documents/Discomfort_Design_Lindsay_Grace.pdf' [Online Resource]
- 4 Grace, L., Consalvo, M., Altizer, R., Phelps, A., 2019. "How to Talk About Games, Today", Game Developers Conference. Retrieved from: '<https://www.gdcvault.com/play/1025718/How-to-Talk-About-Games>' [Online Resource]
- 5 Gunter, B., 2016. Does Playing Video Games Make Players More Violent? Palgrave Macmillan. UK.
- 6 Harteveld, C., 2011. Triadic Game Design: Balancing Reality, Meaning and Play. Springer-Verlag London.
- 7 Juul, J., 2005. Half-Real: Video Games between Real Rules and Fictional Worlds. Cambridge, MA: MIT Press.
- 8 Schell, J., 2008. The Art of Game Design: A Deck of Lenses. Schell Games.
- 9 Shiyko M., Hallinan S, Seif El-Nasr M., Subramanian S., Castaneda-Sceppa C., 2016. Effects of Playing a Serious Computer Game on Body Mass Index and Nutrition Knowledge in Women. JMIR Serious Games. Published online at games.jmir.org. Retrieved from: '<https://games.jmir.org/2016/1/e8>' [Online Resource]
- 10 Zagal, J. P., Björk, S., Lewis, C., 2013. Dark Patterns in the Design of Games. Foundations of Digital Games Conference, FDG 2013, Chania, Greece. Retrieved from: 'http://www.fdg2013.org/program/papers/paper06_zagal_etal.pdf' [Online Resource]



Sustainability and food systems references

- 11 Bortoletti, M., Lomax, J., UN-Environment, 2019. Collaborative Framework for Food Systems Transformation. A multi-stakeholder pathway for sustainable food systems, One Planet network. Retrieved from: 'https://www.oneplanetnetwork.org/sites/default/files/un-e_collaborative_framework_for_food_systems_transformation_final.pdf' [Online Resource]
- 12 Ellen MacArthur Foundation, 2019. Cities and Circular Economy for Food.
- 13 Ellen MacArthur Foundation, 2019. Cities and Circular Economy for Food: Technical Appendix: Global Modelling.
- 14 Food and Agriculture Organization of the United Nations, 2013. Food wastage footprint & Climate Change. Published online at fao.org. Retrieved from '<http://www.fao.org/3/a-bb144e.pdf>' [Online Resource]
- 15 Food and Agriculture Organization of the United Nations, 2013. Food wastage footprint: Impacts on Natural Resources Summary Report. Published online at fao.org. Retrieved from '<http://www.fao.org/3/i3347e/i3347e.pdf>' [Online Resource]
- 16 FoodPrint. Industrial Crop Production. Published online at foodprint.org. Retrieved from: '<https://foodprint.org/issues/industrial-crop-production/?cid=804#Monocropping>' [Online Resource]
- 17 Orliczky, M., 2014. The Dark Side of Sustainability. Published online at nbs.net. Retrieved from: '<https://www.nbs.net/articles/the-dark-side-of-sustainability>' [Online Resource]
- 18 Portney, K., 2015. Sustainability. MIT Press.
- 19 Ritchie, H., Roser, M., 2020. Micronutrient Deficiency. Our World In Data. Published online at OurWorldInData.org. Retrieved from: '<https://ourworldindata.org/micronutrient-deficiency>' [Online Resource]
- 20 Stoknes, P., 2015. What We Think About When We Try Not To Think About Global Warming. Chelsea Green Publishing.