



How to Elongate An Occupation

Ye (Jacee) Tong and Muzi Li



Knot

[n.]
a fastening made by looping a piece of string, rope, or something similar on itself and tightening it.

[v.]
1. fasten with a knot
2. make tangled

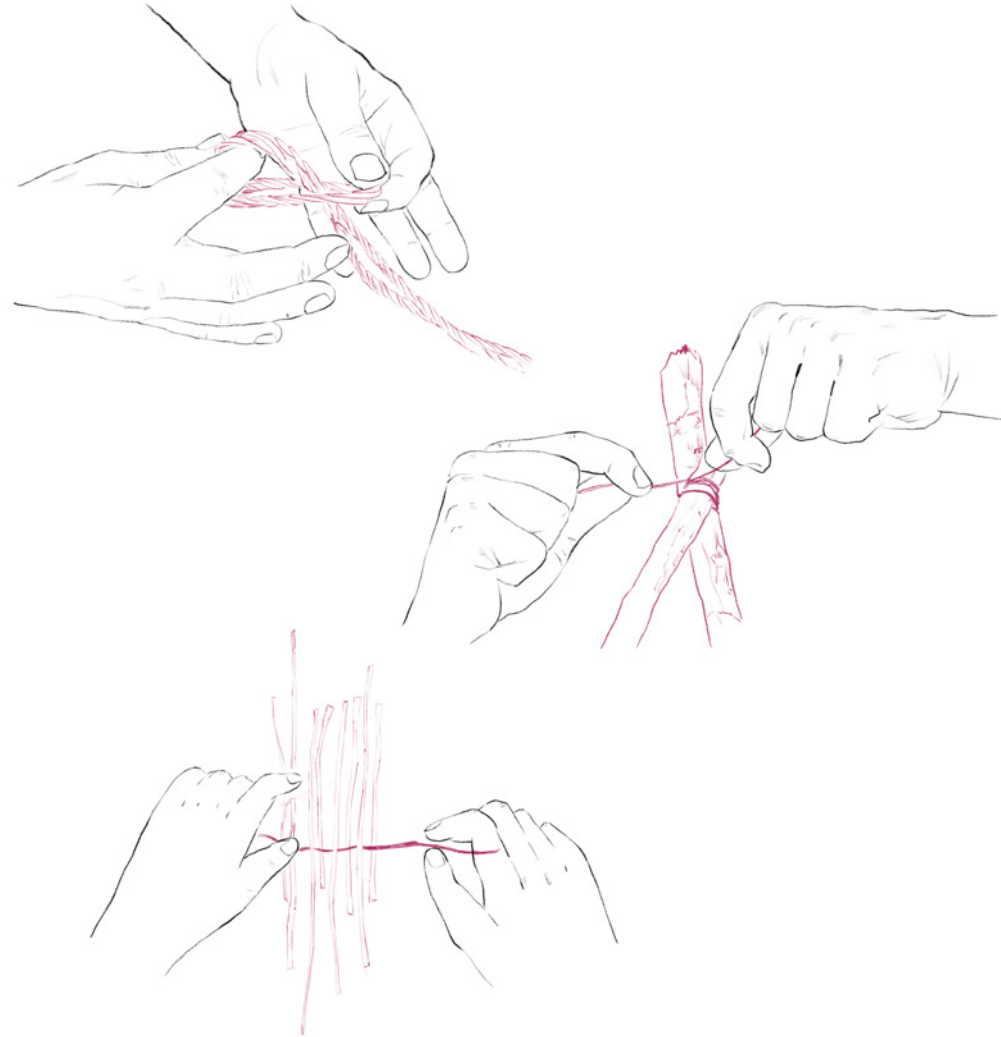

Knot is simultaneously a construction method, an embodied language, a tool for connecting, and a self-initiated infrastructure.

[infrastructure]

(1). Knot enables climbing. A simple persik knot enables movement to inaccessible spaces. (2). To approach a place vertically without a ladder, whether it's a building or a tree, tie a figure-8 knot to a trustworthy structure. Connecting to the long hanging rope are two loops, both connect to the rope with persik knots, one becomes a step for feet and another holds onto the harness. A persik knot will lock itself when dragged and becomes movable when no weight is applied. Thus alternating body weight on the two loops will enable the climber to climb upward with minimal effort. (3). Knots help transport building materials upward. The alpine butterfly knot perfectly fulfills this need: it can form a loop at any point of a rope for holding or hanging objects. In combination with a pulley system, which will largely decrease the force used to carry object upward, (4). the infrastructure for inhabiting a space is complete.

[crafts]

Knots will also connect matters together, transforming lines into surfaces. (5). Crocheting, (6). knitting, (7) weaving, or even (8) making a dreamcatcher, are all ways to use continuous knots, each following different logic that could inform the final forms.

[grid system]

A grid system can largely facilitate the use of knots and fabrics as flexible spatial tools. It can be established in the early stage of an occupation and lasts towards a long-term living. In a forest, trees can be a grid system. When squatting in a new place, examining the existing structures and making use of the as-found conditions would be a good idea. (9). To make pits for installing columns, a homemade manual drill will do the job. It can be DIY from a gardening drill by welding a piece of reinforcement to the tip as a centring rod. (10). In soft soil, it can easily go around 1-meter deep. (11). A pre-made base for screwing columns in provides extra flexibility to the space. (12). Once the column base is done, columns can be installed easily. (13). Welding rings to the columns provide the possibility for (14). knotting, (15). hanging stuffs, (16). or even weaving, to happen. (17). The top of the column is designed in a way that facilitates the horizontal structures, the beams, to be added. With beams, you can make a roof — a sheltered space — from a bricolage of any available materials. (18). For example, corrugated metal is an easy-found material in recycling centre; (19). a tarp will also do the job. (20). A grid system, combined with the versatile use of knots, will help transform the space into

the one that fits the needs of the squatters/occupiers. (21). Besides partitions, the columns can also be used for creating an enclosed space. (22). Tying any materials at disposal — tree branches, metal sticks — for structure is a good idea. (23). Welding shelves onto the columns, (24) adding a cover will turn an open space into an interior. It is also a good way to build your own greenhouse with cheap materials like polycarbonate panels.

[mycelium panel]

Growing mycelium on weaving pieces will strengthen the fabric and turn it into a solid. Mycelium, the underground network of fungus, can be used as bio-material for space-making. There are low-tech ways of growing mycelium in a non-lab environment. The growing process contains sterilising, inoculating, incubating, and drying. (25). To sterilise the substrates for mycelium, you can use limewater as a cheap replacement. Add 15g calcium hydroxide into 1L water, mix well, and it is ready for use. (26). Wood chips are a great substrate for mycelium. (27). So does a plant-based fabric. By adjusting the density of the weaved pieces, you can change the stiffness and transparency of the panel. (28). Sterilise everything by submerging all substrates in limewater. (29). Draining the substrate after it has soaked will increase the success rate, as

limewater can harm the growth of mycelium. It is totally fine to reuse the water. (30). Now you can inoculate the substrate with spawn. Check your local suppliers for *G. lucidum* spawn starter set. Start with adding 70% water into the substrate: $\text{Mass (dry wood)} * 0.7 = \text{Mass (water)}$; and add 16% of *G. lucidum* spawn in weight ratio to the wet substrate: $\text{Mass (water+wood)} * 0.2 = \text{Mass (spawn)}$. (31). Cover it with a lid with some holes, and wait for 21 days for it to be fully incubated. Remember to spray some water around every seven days to keep it moist. (32). Dry it in an oven at 60-80 C. You can easily dry a thin layer on a very sunny day, too. The mycelium panel will then be ready to use.

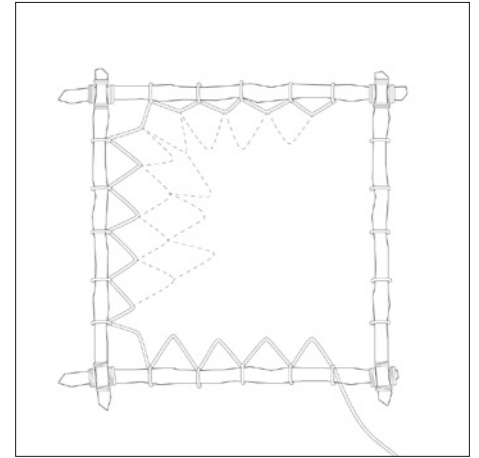
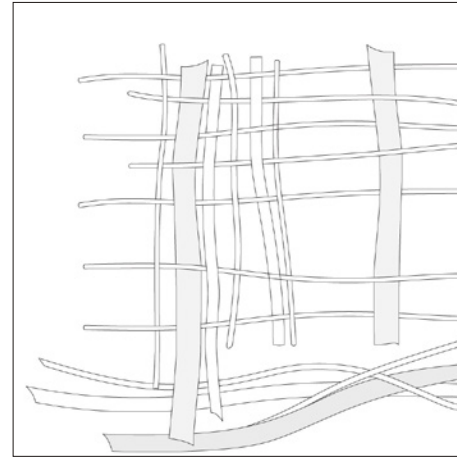
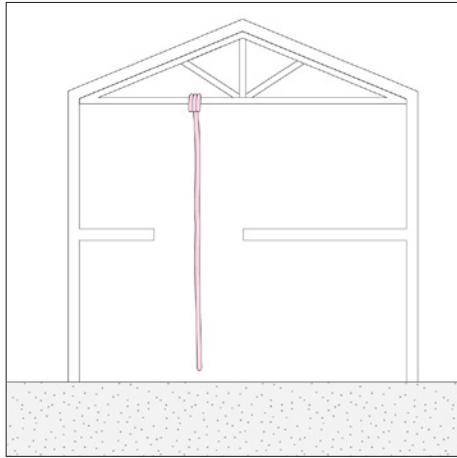
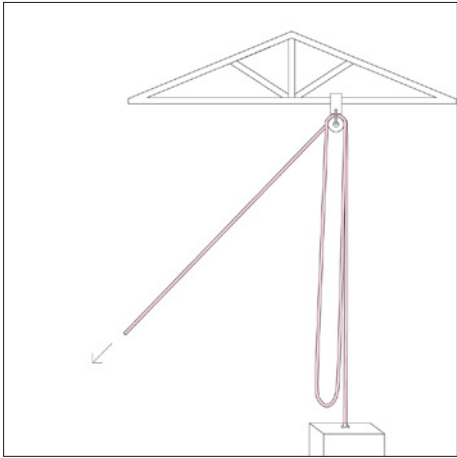
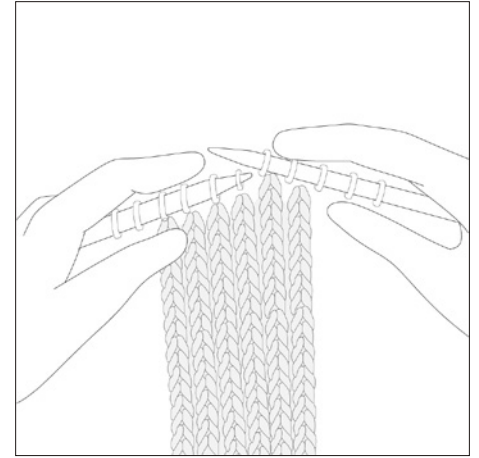
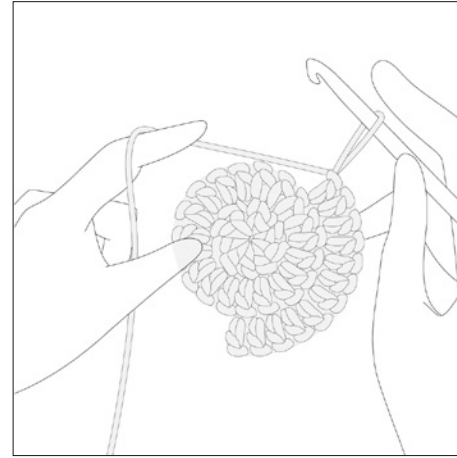
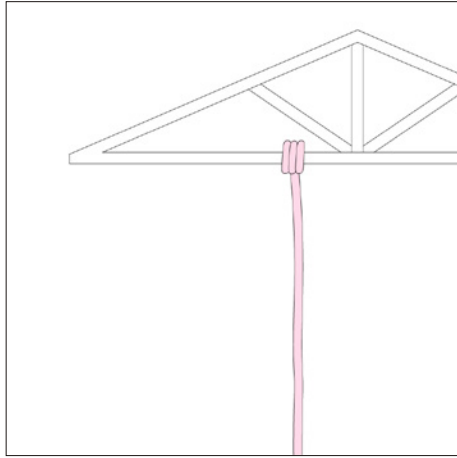

knot soil print

knot soil print

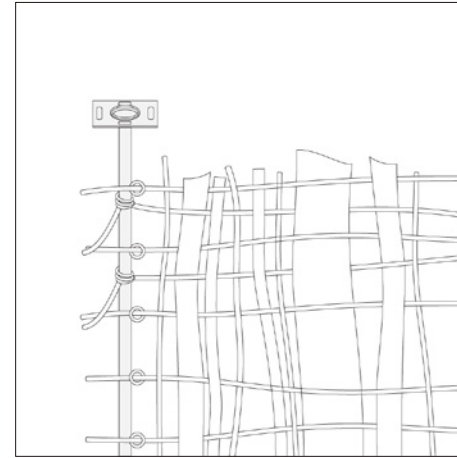
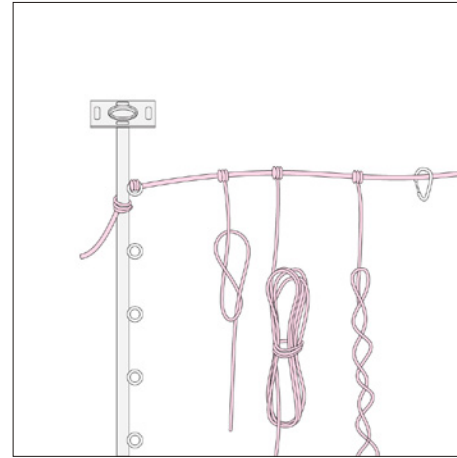
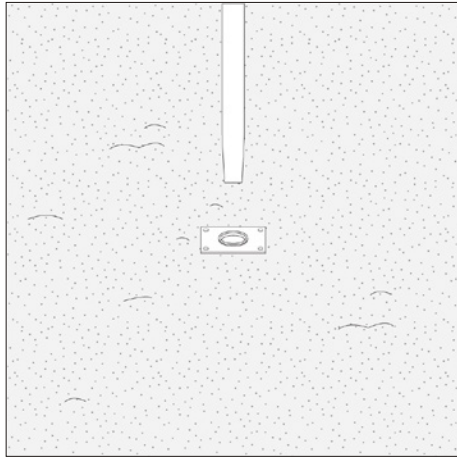
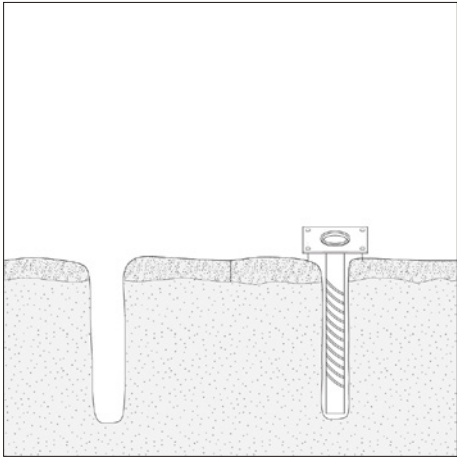
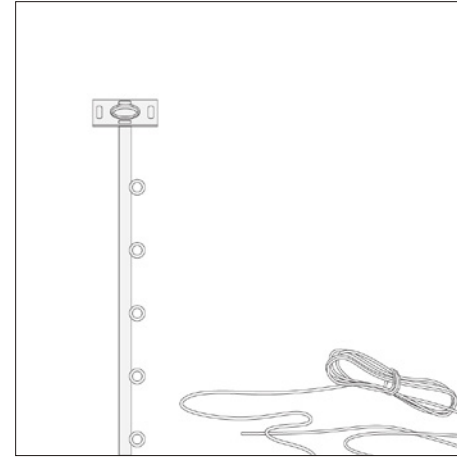
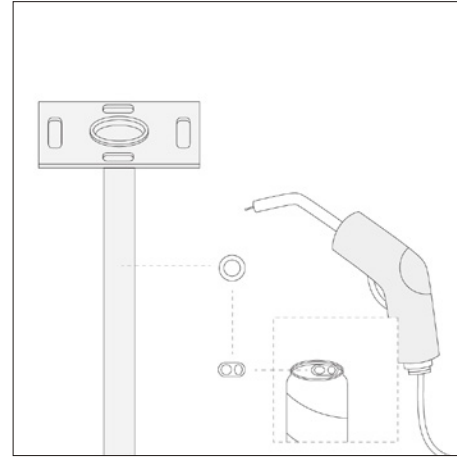
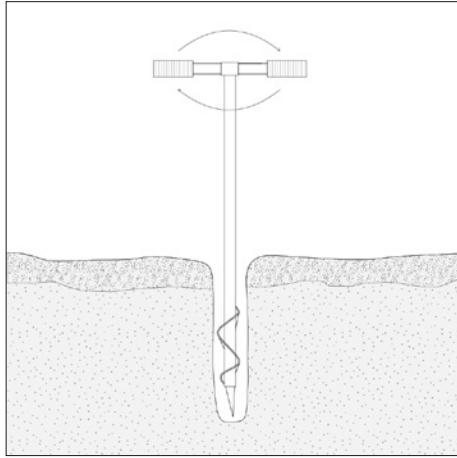
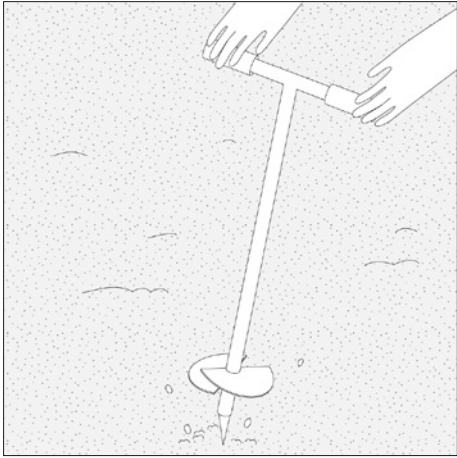

knot soil print

knot soil print

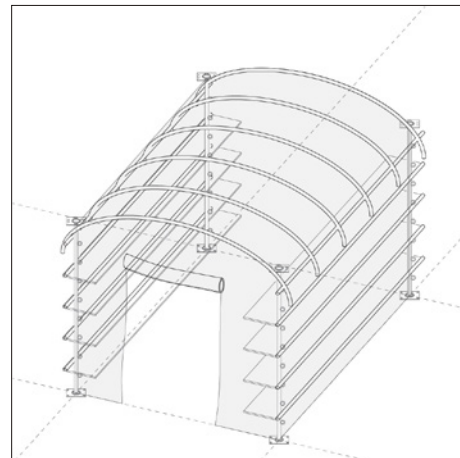
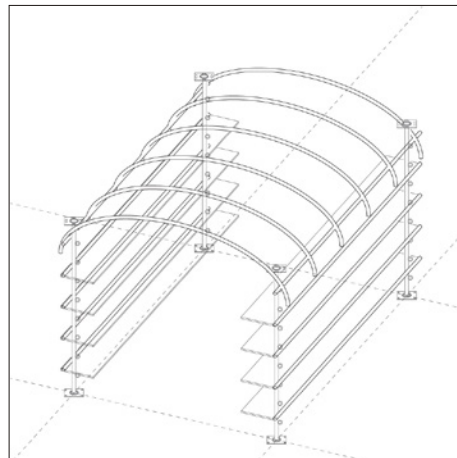
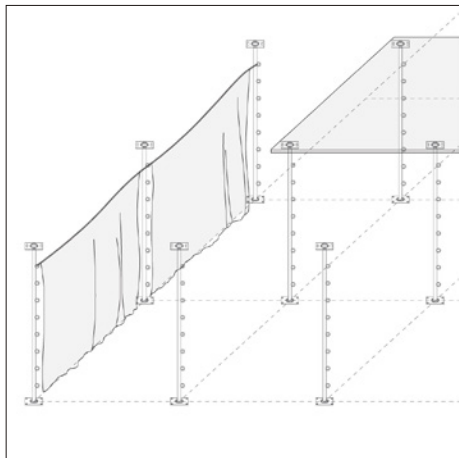
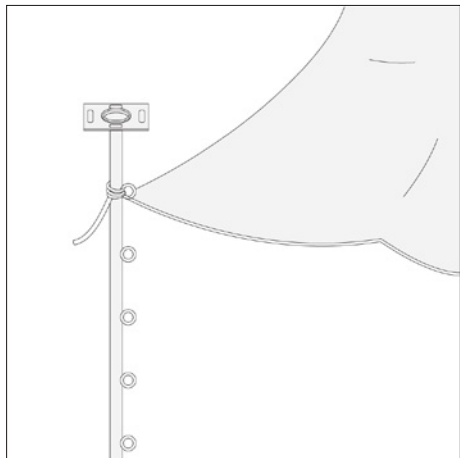
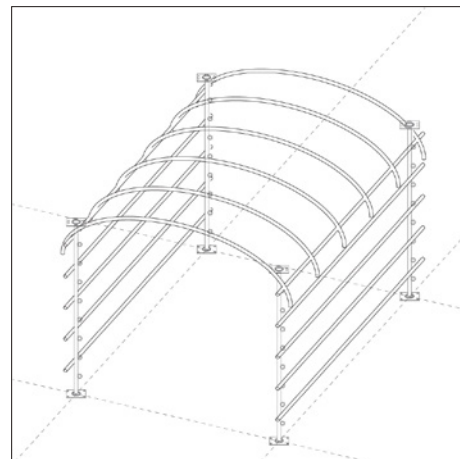
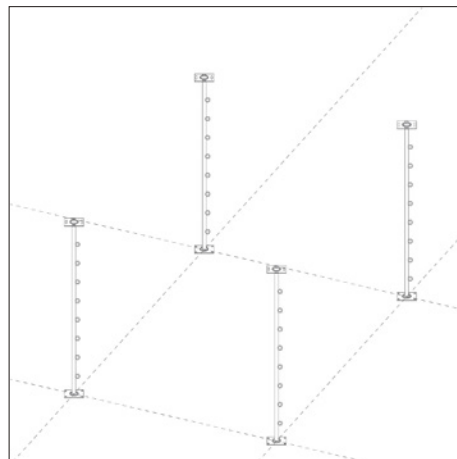
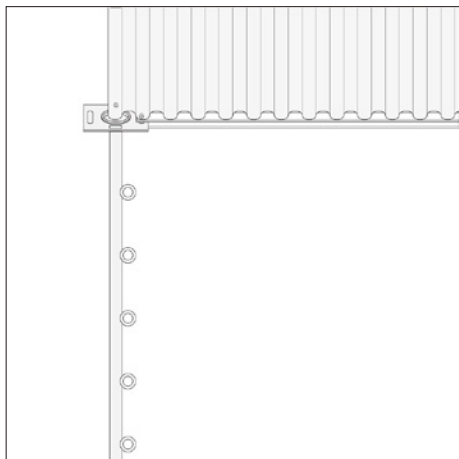
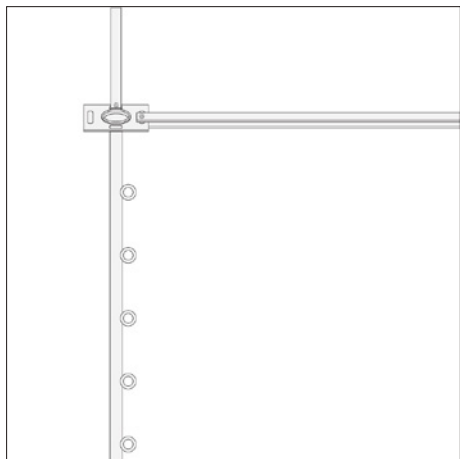

knot soil print

knot soil print

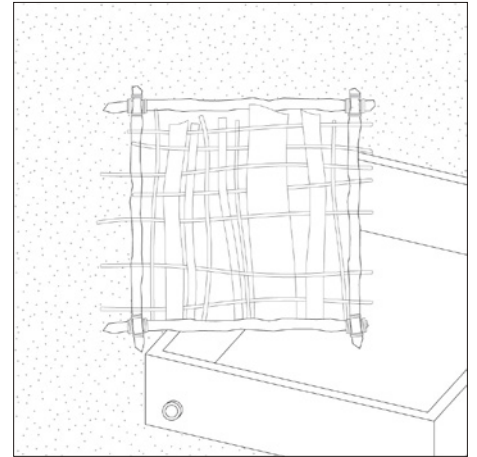
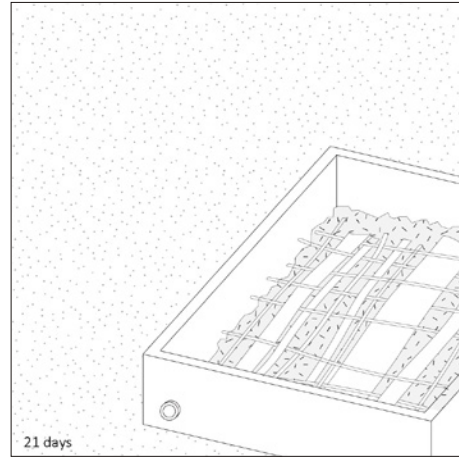
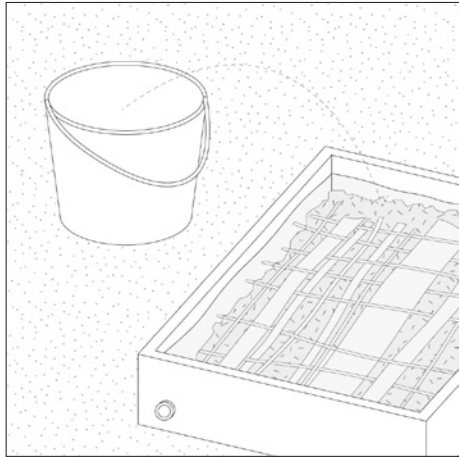
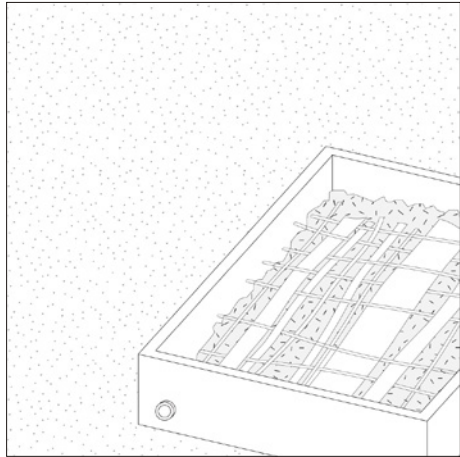
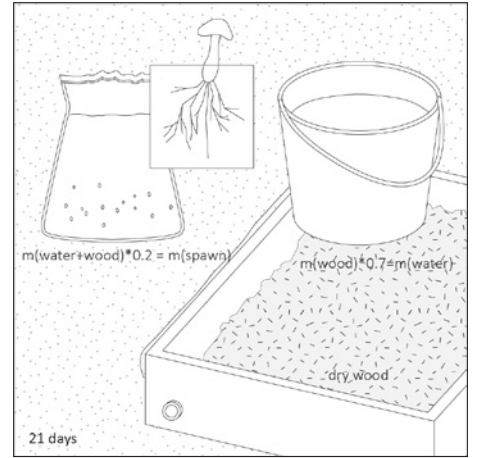
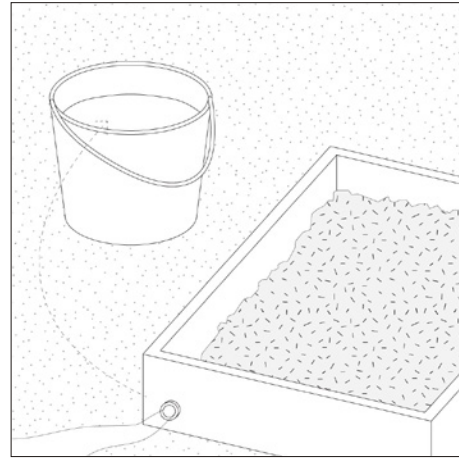
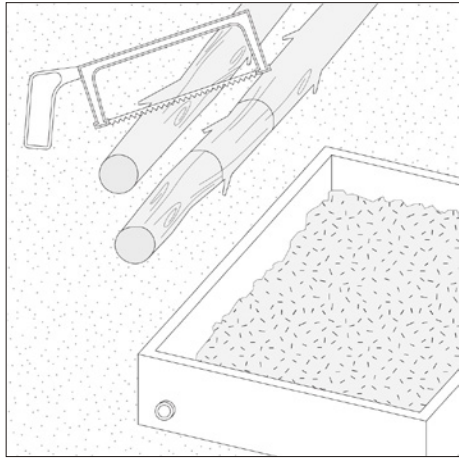
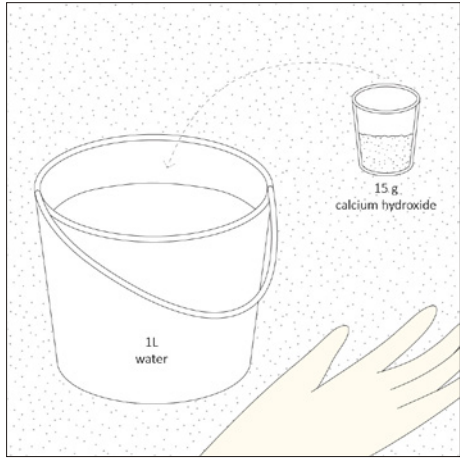



Soil

[n.]

1. the upper layer of earth in which plants grow, a black or dark brown material typically consisting of a mixture of organic remains, clay, and rock particles.

2. the territory of a particular nation.



Soil is in charge of nurturing life, circulating energy, gathering heat, filling the gap. To care for and entangle with soil is to shed lights on possibility of living dependent on soil.

[clay building]

(1). Clay is a great construction material used frequently in vernacular architecture. It can be acquired by digging around 1 meter below the top layer of soil. (2). Dig the ground and take the soil deeper than 1 meter. (3). They will be perfect for repairing, building, and clay-making. (4). Do not overuse the soil over its limit. (5). The newly dug the soil, transported in a container, is often coarse and needs to be refined (6). you make the soil finer by adding water in the soil, then grinding and draining it using the colander, (7). This mixture is called slip-clay. consider packing it in cloth and hang it for drying (8). After 24 hrs drying, you get a solid clay (9). To repair a building in a torn-down condition, consider using clay to ram the wall. (10). An earth rammer / tamper can be useful. (11). To ram the soil is a communal act where every body is included. (12). Eventually, you can shape the space into any form of your like. (13). Ramming earth takes time of making and waiting. It needs to be done layer by layer. (14). The outermost layer can be formed with a spatial intention, so that soil becomes a built-in furniture. (15). For instance, it can be a place to store all the kitchenware and seasonings, and it will become a kitchen for use or (16). A working station for to prepare your food.

[fireplace]

Fireplace forms a functional core for cooking, firing, keeping warm and dry. A hearth is a place to gather within the community. A DIY way to make a fireplace would be reusing a wasted metal can ensure heat conservation. The metal can can be (17). Drilled and cut to be (18). hollow inside and you can put firewood inside to form a space for baking(19). Ingredients will be (20). transported from the anarchist farm in the kitchen where the (21).Collaborative making of food will happen. (22). Putting firewood in the heat-conserving core, (23). It will become a oven where food can be baked here.

[rain water collecting system]

Besides gaining warmth and having cooked food, (24). Good amount of clean water is also essential for people who live an autonomous life. (25). Creating a device to collect rain water requires a gutter connected onto (26). a column and a roof. The roof will be connected into (27). A roof system so that the water collected can be (28). Transported, filtered and stored in an underground water tank. (29). The water collected, even not clean enough for drinking, is still very useful for (30). Watering plants. (31). An environmentally sustainable faming strategy is permaculture faming, (32). Which will be a major source of food.

[mending with clay]

Clay is a stiff construction material that has been practiced in different indigenieous cultures. Besides shaping the interior, it is also useful for (33). Renovating an existing building strengthening existing structure (34). In combination with the brick structure. (35). rammers, tampers, hammers, driller and hammers are all useful tools for this construction. (36). A formwork, usually constructed with wood pieces and metal connections, is often used to keep shape the rammed form ad keep surface aligned. (37). The rammers will be be used within the parameter of the formwork. (38). By layering soil and ramming the soil within the formwork, (39). The rammed earth starts to wrap around the original brick core and provides stronger support for the existing structure and (40). Replace part of the wall system with a thicker columns. (41). Rammed earth is flexible and plastic, affording different kinds of use. Close to the gardening area, a thick rammed column can be seen as a tool-stand that (42). one adds working platforms and (43). Hang tools. (44).This is a perfect spot to do gardening works, planting seeds, changing pot, and so on (45). even for basic wood works. (46). For example, creating a seedling tray for fragile plants, and (47-48). bring the tools to the gardens.

[farming and sharing]

From the growing of plants, we can observe how soil circulates the autonomous life with growing and degrowing, composing and composting. (49). Seeds need to be grown in appropriate temperature and humidity, and smaller pot, such as the used egg box, will be suitable. (50). The farming area should be plowed before (51). Putting the sprouted seeds in and (52). Let them grow. The grow of the plants is facilitated by waste compost. (53). Human waste can be composted into a natural fertilizer (54). In a container with sand, wood pieces, leaves and put in a place in good ventilation. (55). The fertilizer can be manured for the plants every two weeks (56). For them growing quicker and bigger.

It is exciting to share the fruit from farming with all the friends in town. (57). Harvesting in time is important to avoid waste and (58). The fruit harvesting could be carried by the gardening cart to (59). The give-away shelf, where the fresh produce and (60). Be shared and distributed to other people living in town. The giveaway shelf shares more than just food, it is a also a crucial institution where people gain spatial agency. (61). If a building is ruined and has broken holes on the wall, (62). One can take measurements of the incomplete area and (63). Search a replacement panel in the exchanging shelf and (64). Even borrow hammers and screw drivers to fix it.

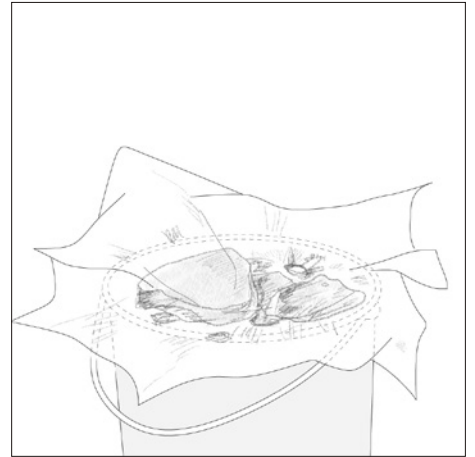
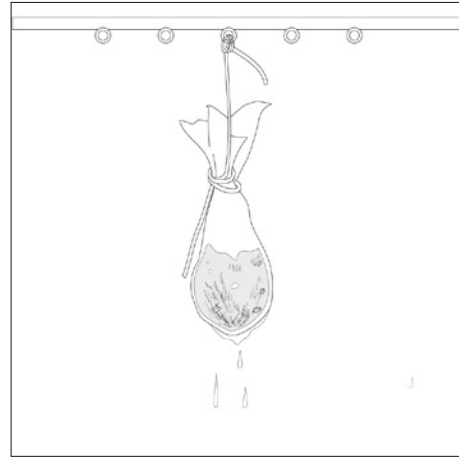
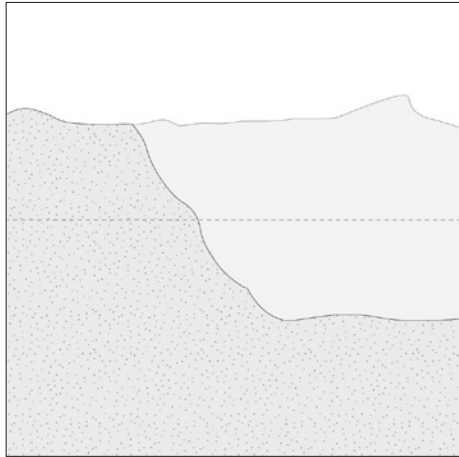
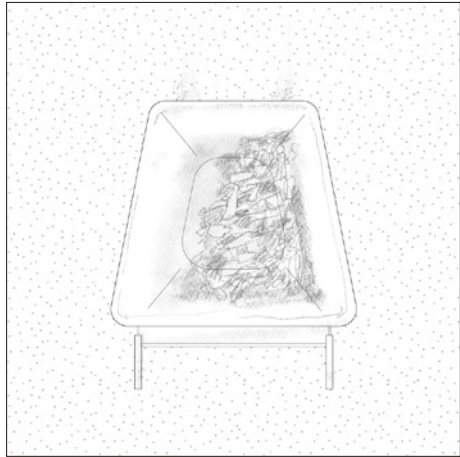
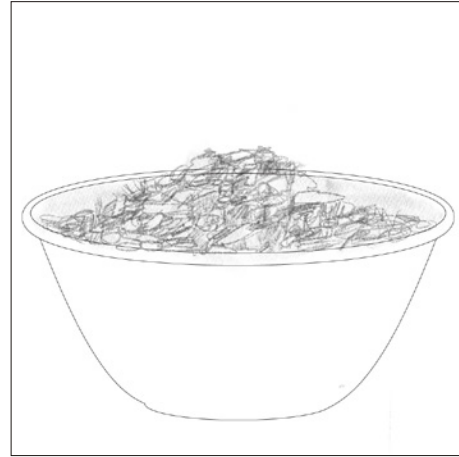
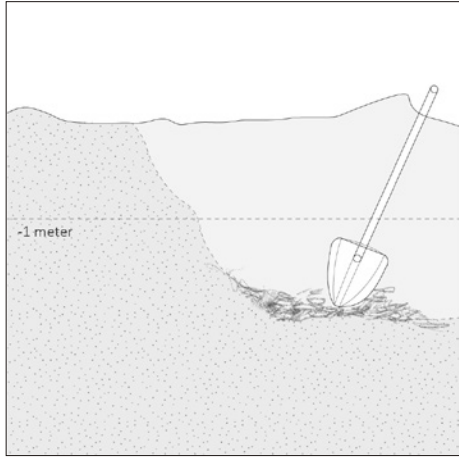
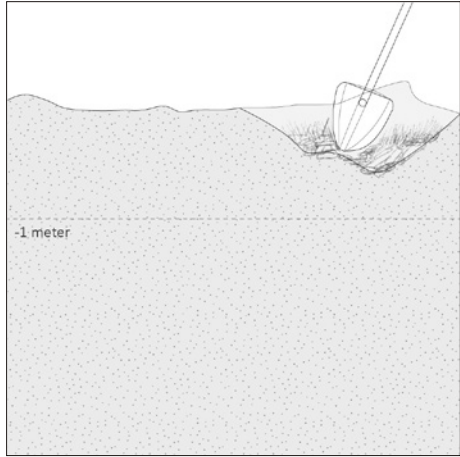

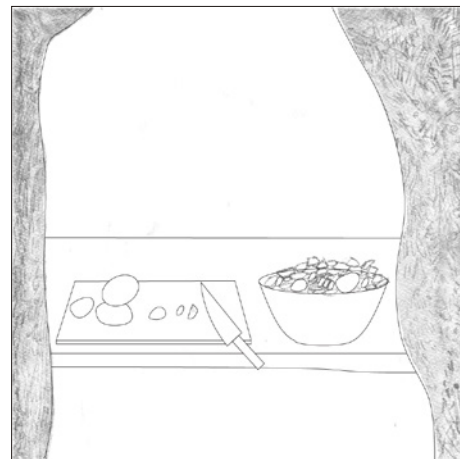
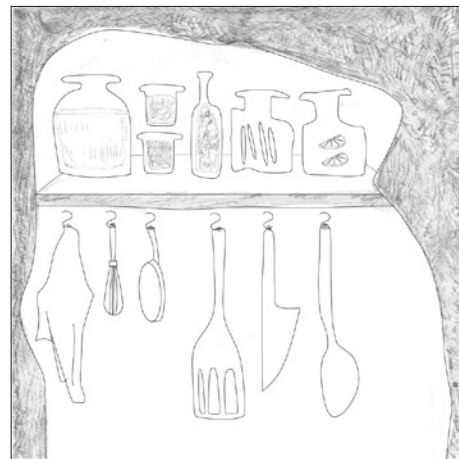
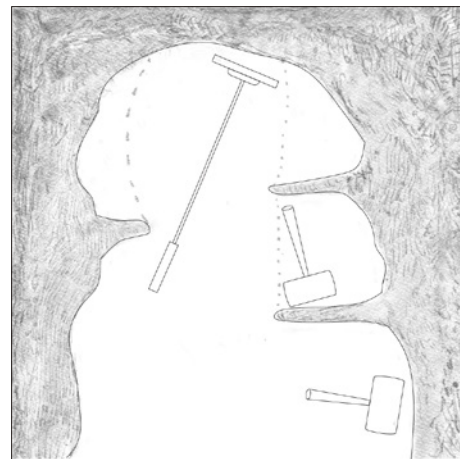
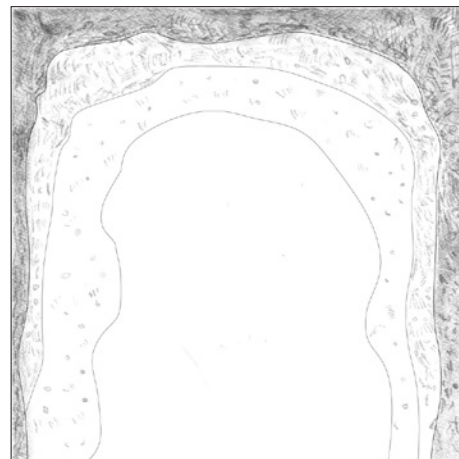
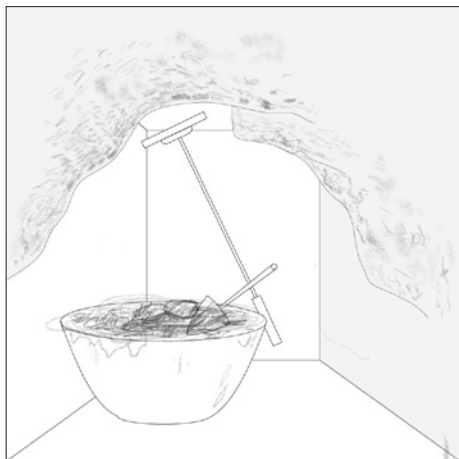
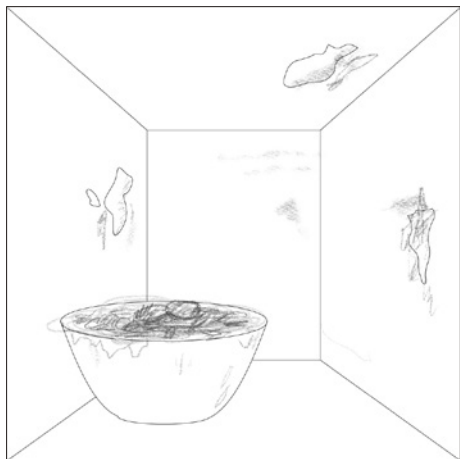

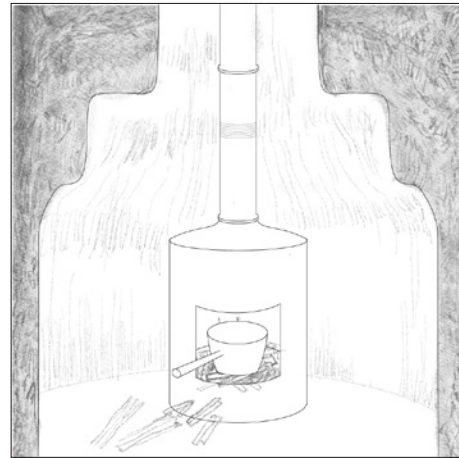
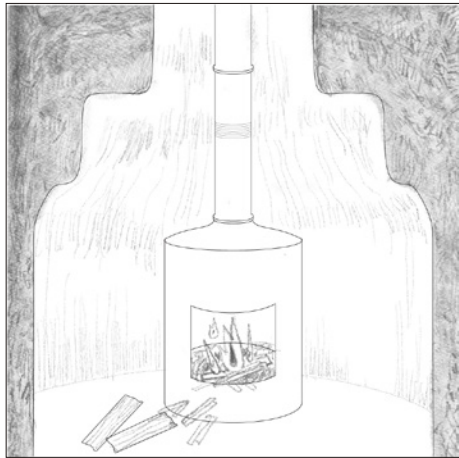
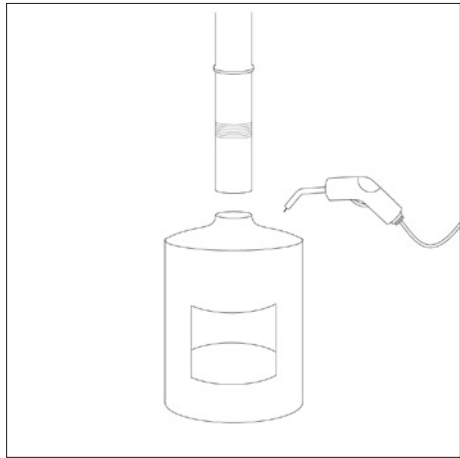
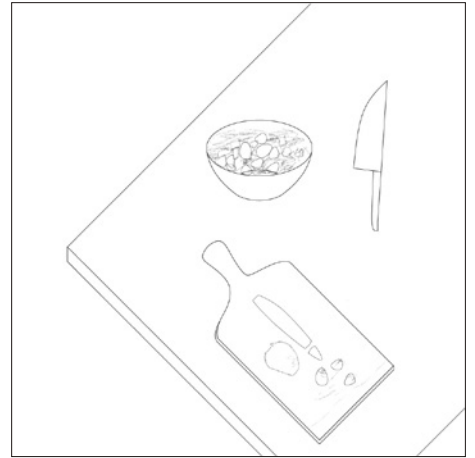
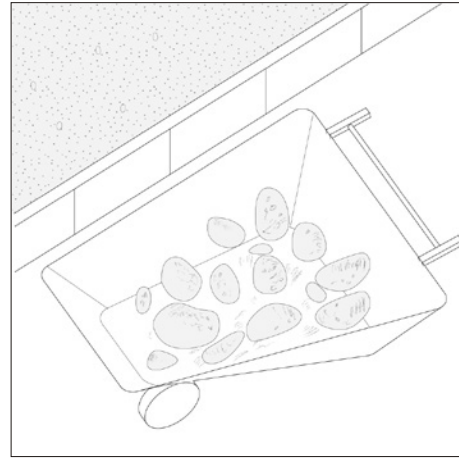
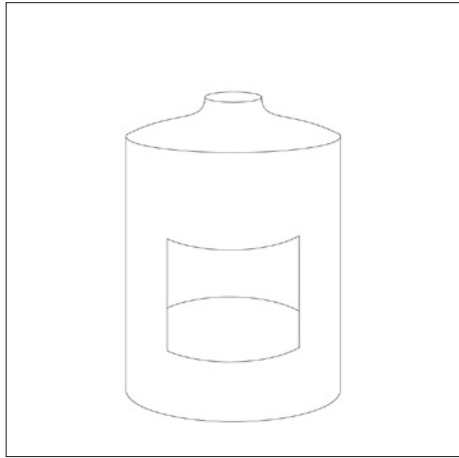

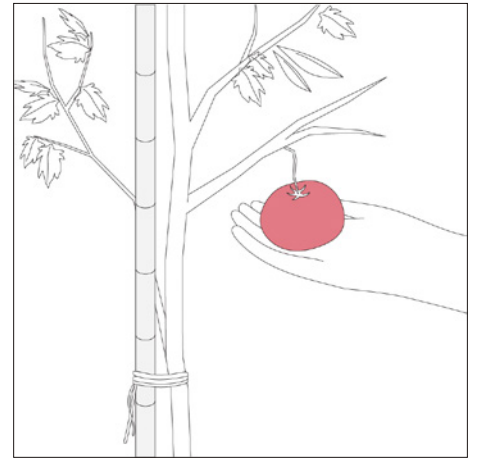
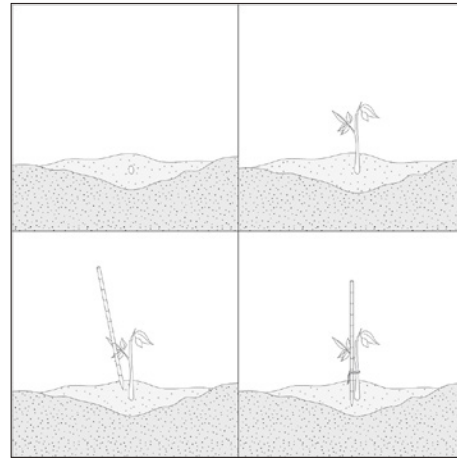
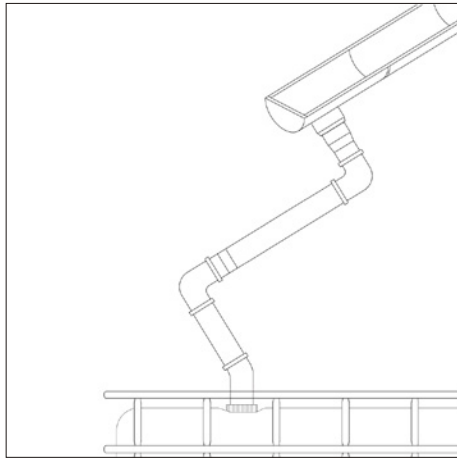
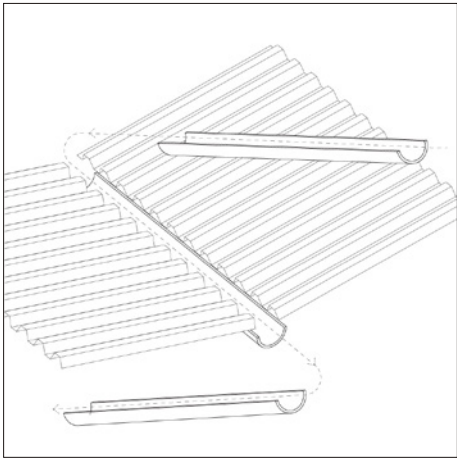
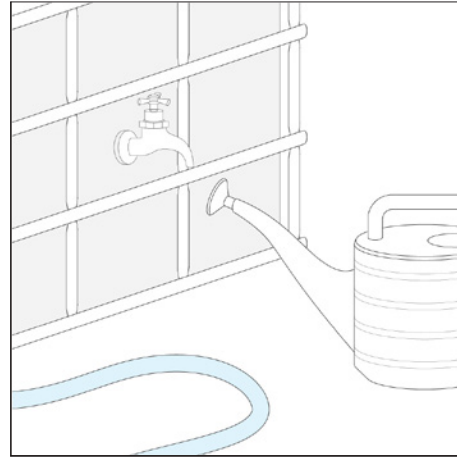
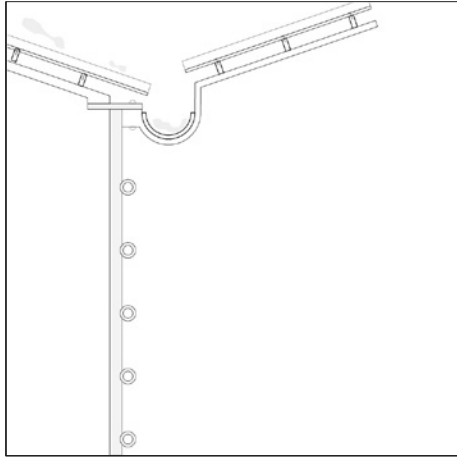
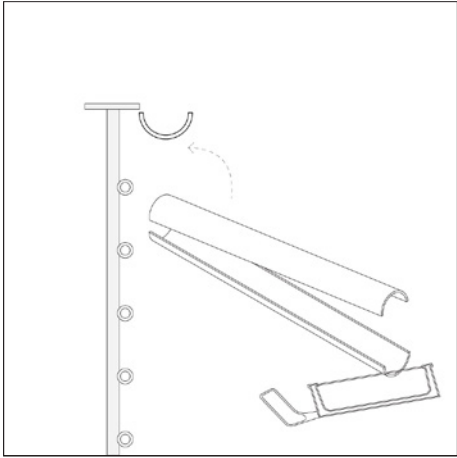

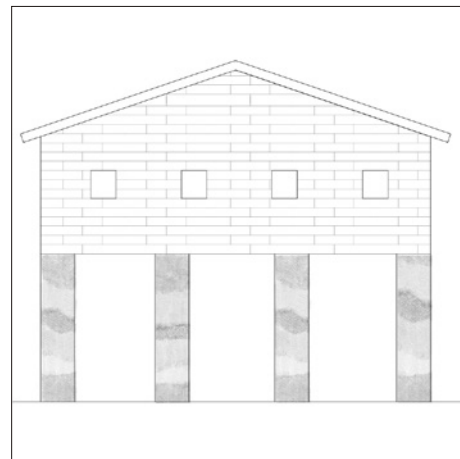
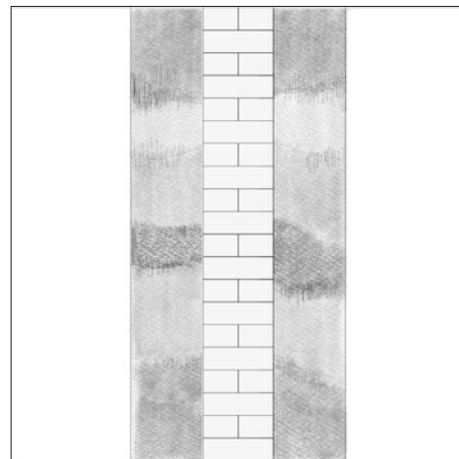
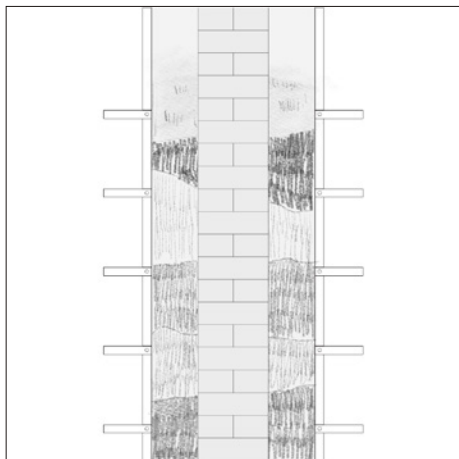
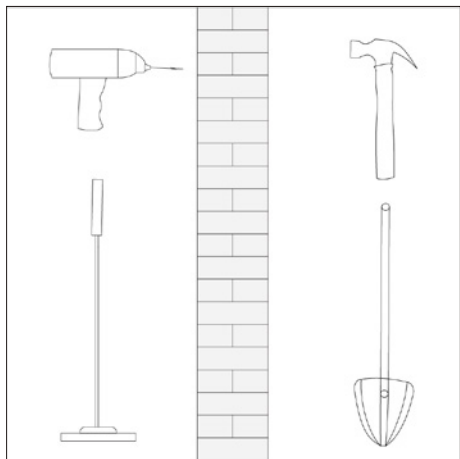
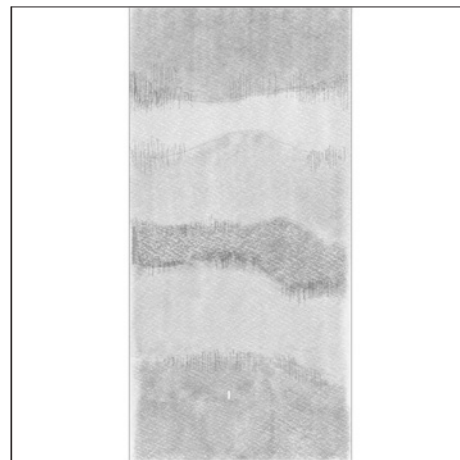
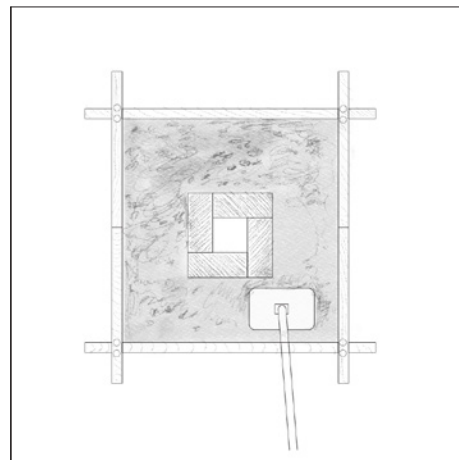
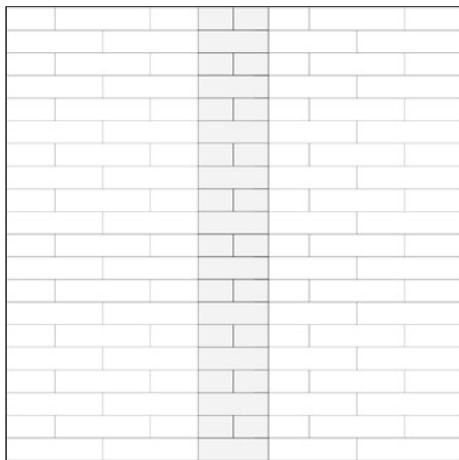
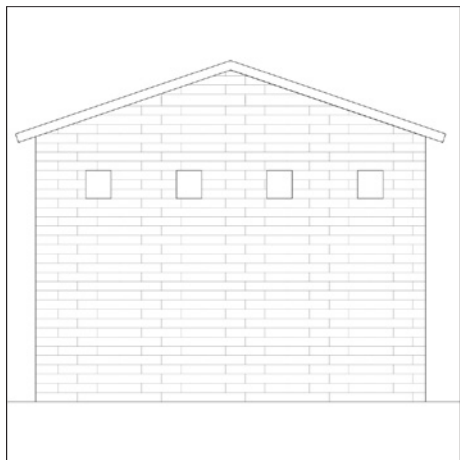

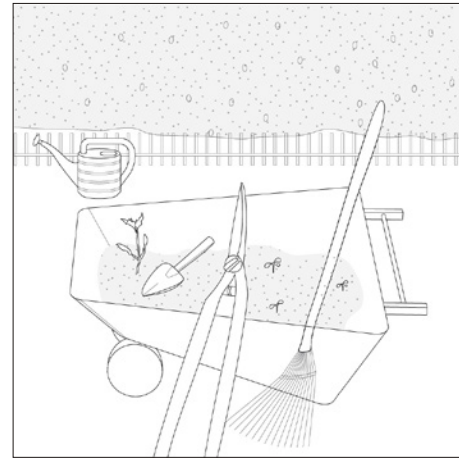
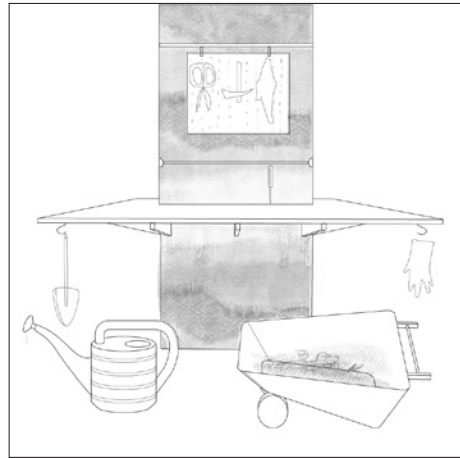
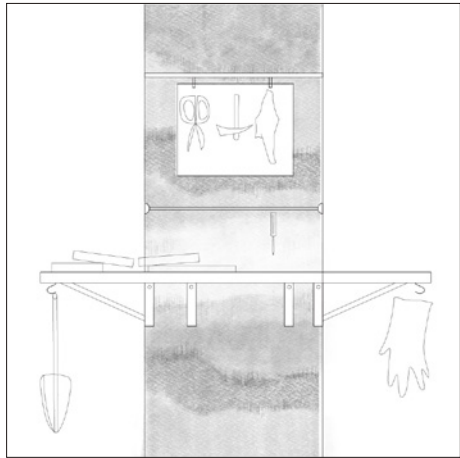
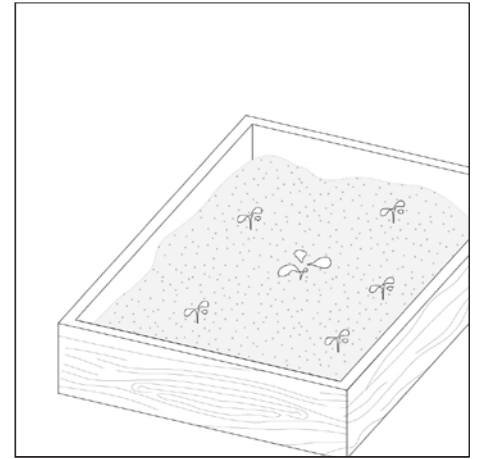
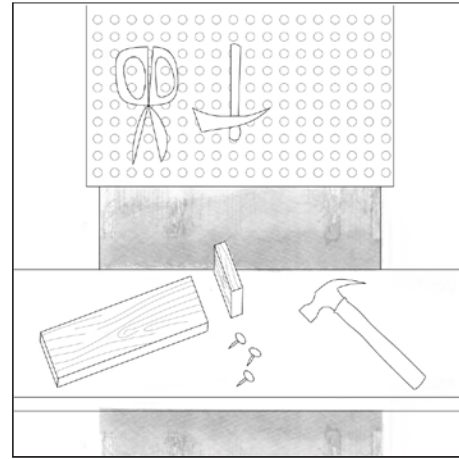
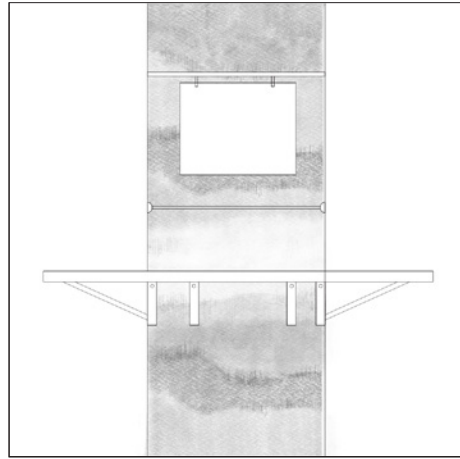
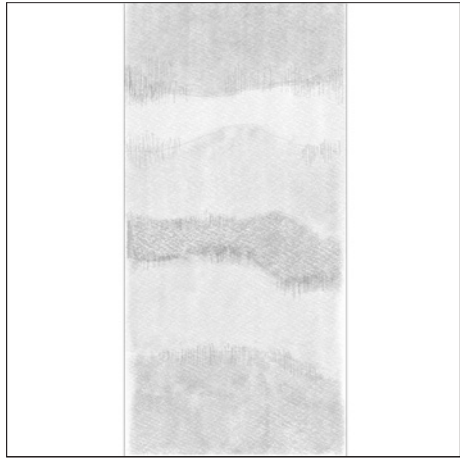

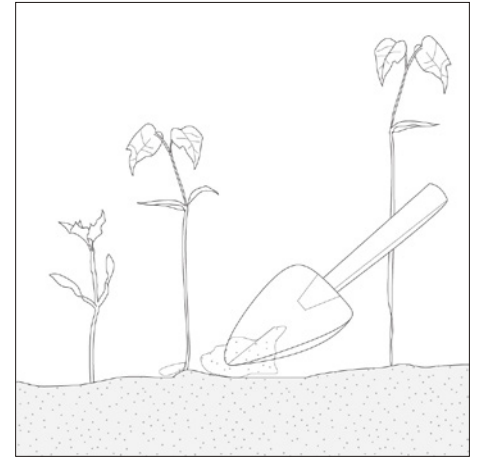
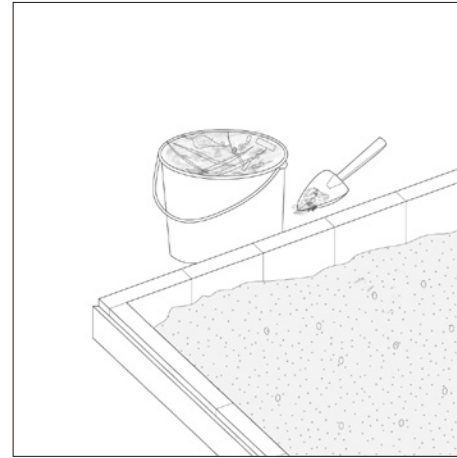
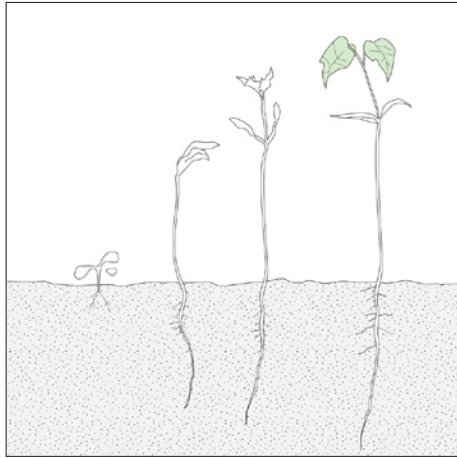
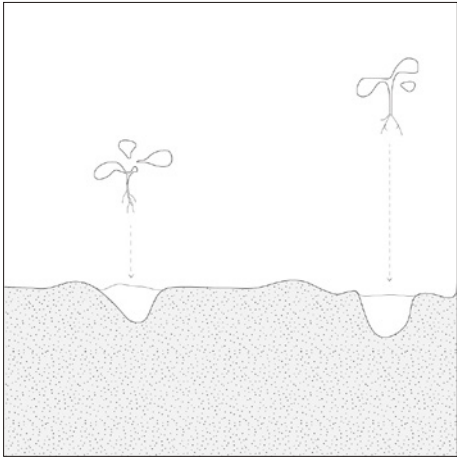
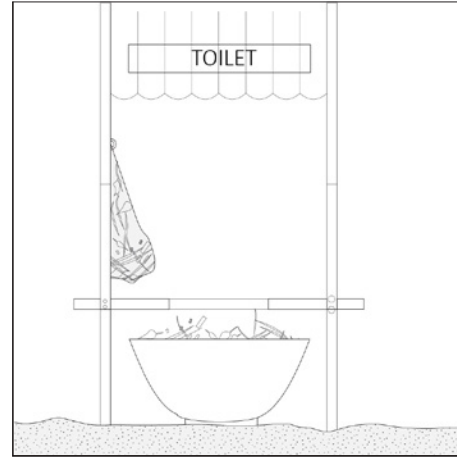
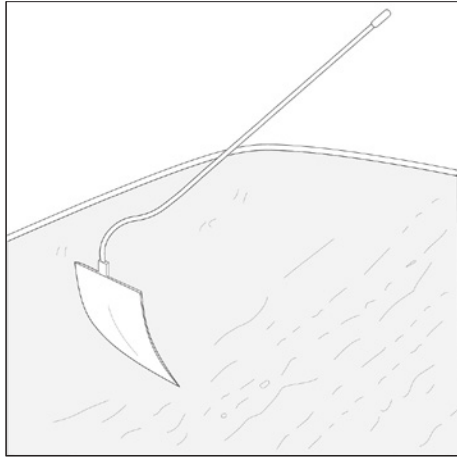

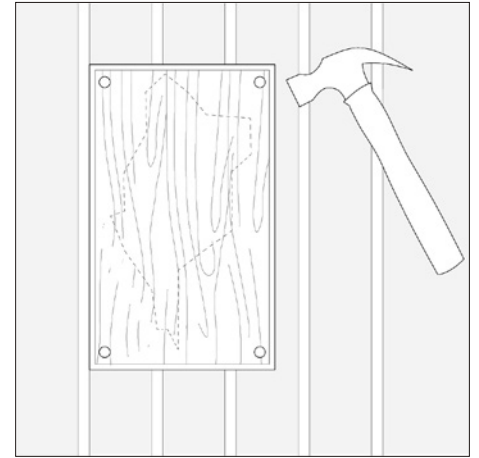
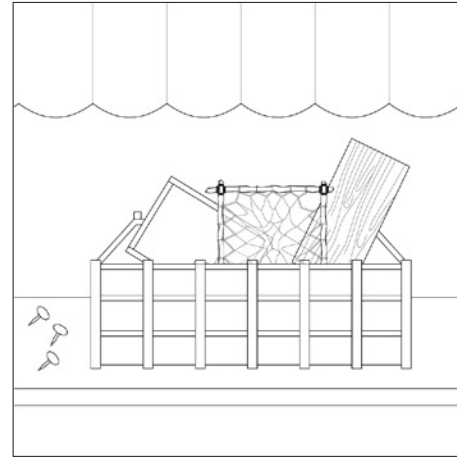
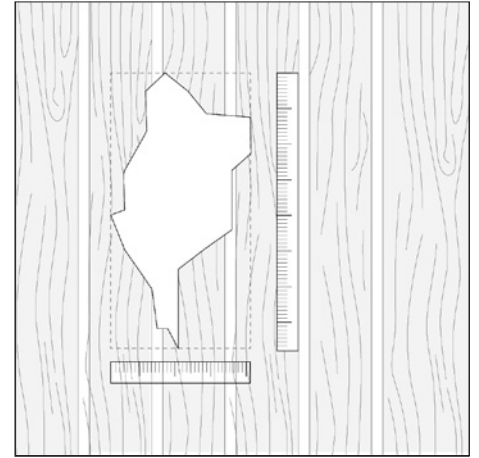
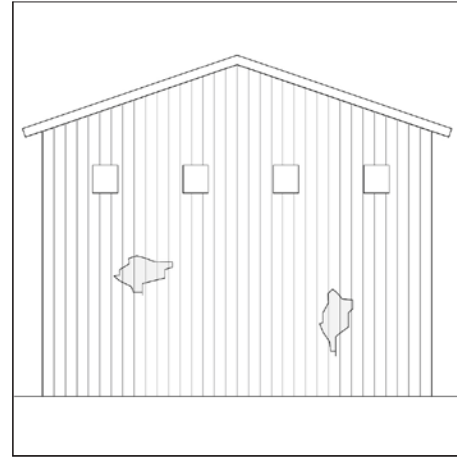
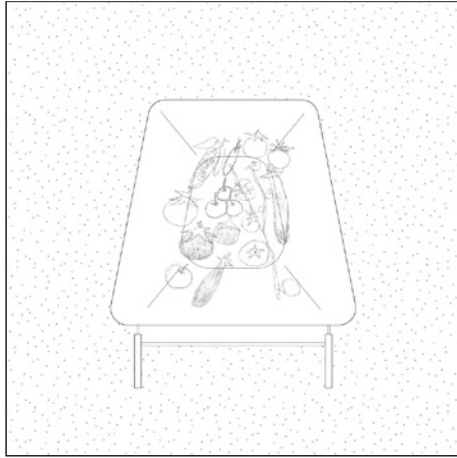



Print

[n.]

- 1.the text appearing in a book, newspaper, or other printed publication, especially with reference to its size, form, or style.
2. an indentation or mark made on a surface or soft substance.

[v.]

- 1.produce by a process involving the transfer of text or designs to surfaces.

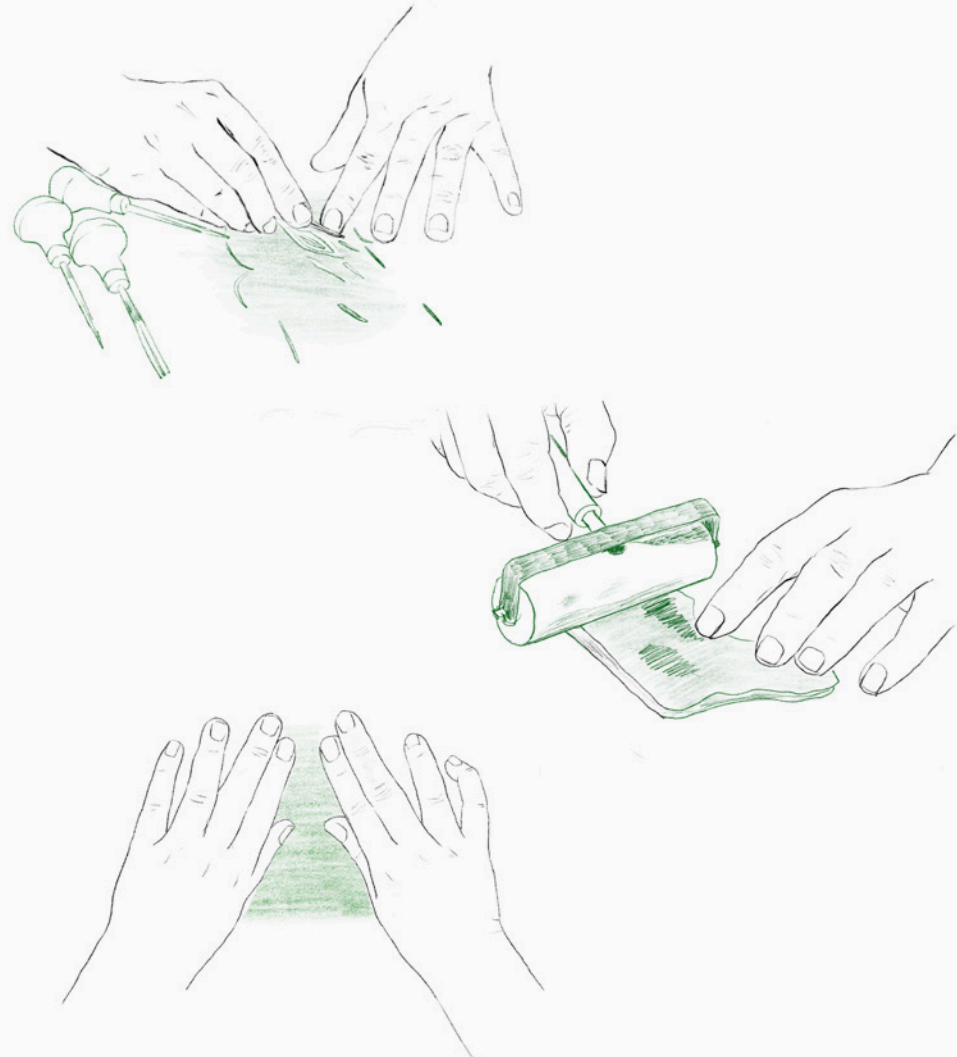

As a practice that critically remembers, archives, and leaves traces, print is simultaneously an action, a material, a machine, a place, and a network.

[printing out, making zines]

(1). A printer can bring a revolution. “While the stock image of the anarchist as a masked bomber or brick thrower prevails in the public eye, a more representative figure should be a printer at a printing press.” (Kathy E. Ferguson, *Letterpress Revolution - the Politics of Anarchist Print Culture*).

Historically, printing not only documented but also constituted the global grassroots anarchist movement from the late nineteenth century to the 1940s. (2). For building network in the landscape and nomadic scale, distributing printed discourse is a common practice for the marginalised group to be seen. (3). Spread the words everywhere. (4). The printed material will also become a great source of documenting our own history. Build your own anarchist library. (5) Print can involve various formats: stickers,

posters, zines, booklets. Through these materials, literature-, theoretical and embodied knowledge circulates in the anarchist community and outwards to broader public. (6) Making zines, for example, is a great decentralised way to visualise, document, and spread the idea. Take any kind of paper. Fold it in a way as shown. (7) Make a cut in the centre, (8). and a booklet is done!

[lino-cut printing]

(9). Print encompasses not only an end product, it is also an action. A collective one. Linoleum printing is a great collective action to build solidarity. (10). When desired material is not available, even a potato can be made into a stamp. (11). Carve the negative space. (12). Apply ink with a roller. Ink can be made from burnt wood, or even a beetroot. And it is good to make stamps everywhere! (13). Print can happen not only

on paper. Making imprint on clay allows one to turn prints into panels for building. (14). Roll the clay flat, cut it into pieces, and be creative about each panel! (15). You could even use your body as a printing tool. (16). Each panel will be unique, telling the story of every participant. (17). Clay is also a great material to transfer the lino print into something more permanent. (18). With the pattern carved onto a linoleum block, press it onto the clay. (19). Remember to let the clay dry thoroughly before (20). firing it in a kiln. (21). Taking advantage of the grid system, you can define a space (22). using knots and (23). the printed clay panels. (24). The panels can be assembled into a wall or a partition, creating a space that is both functional and visually appealing, reflecting the collective effort and creativity of the community. Each panel, with its unique print, tells a story, making the space a living

archive of the community’s experiences and expressions.

[network for solidarity]

(25). Print forms nodes in a network of solidarity and grassroots direct action. It is crucial to connect with international allies for different skills and voices. (26). Although the idea of anarchism advocates for a complete abandon of the system, it is sometimes also wise to find the glitch in the system and (27). legitimise the squatting or occupation. (28). Movement like Hambach Forest Occupation successfully halted the mining through suing the mining company. (29). the anarchist study through documents and policies, (30) write their own stories, publishing their ideas on the communal website, meanwhile, (31) creating brochures to spread out their ideas (32). ask for local participation to include wider voices

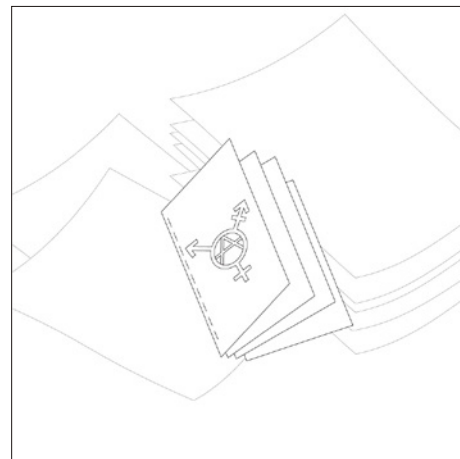
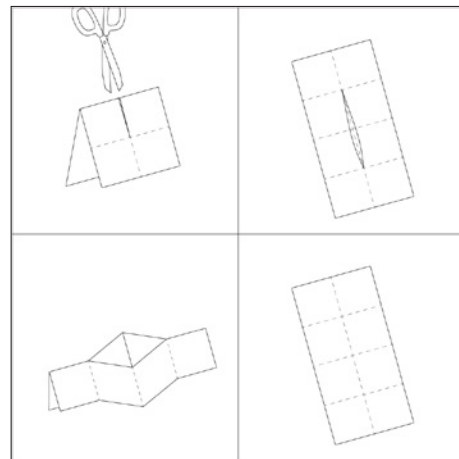
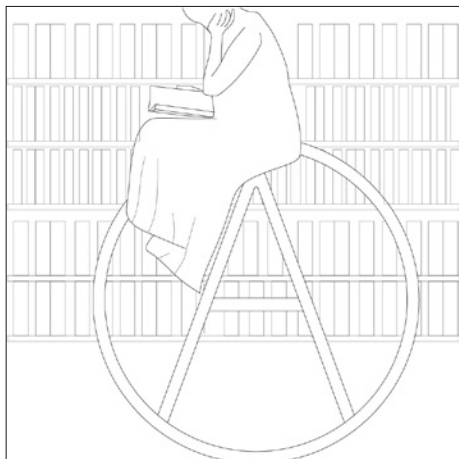
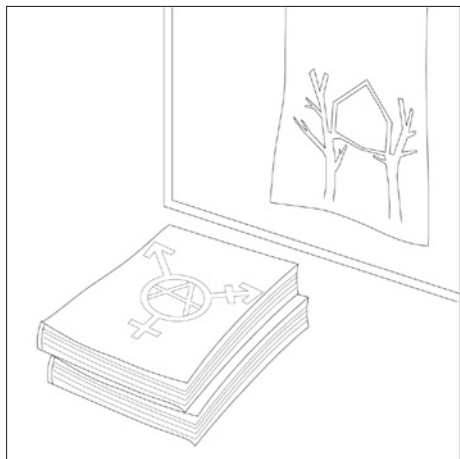
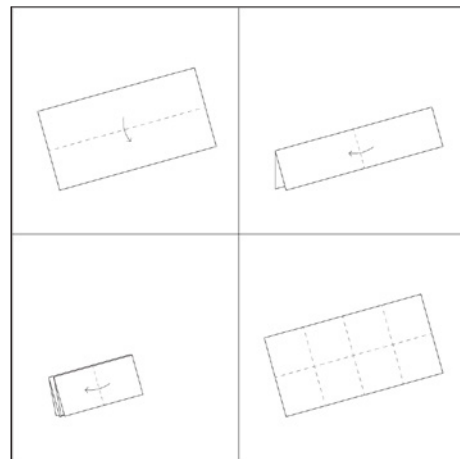
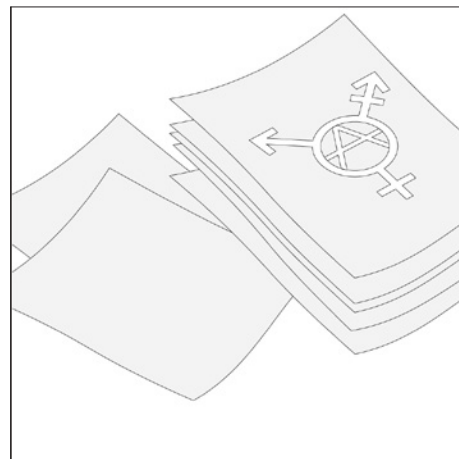
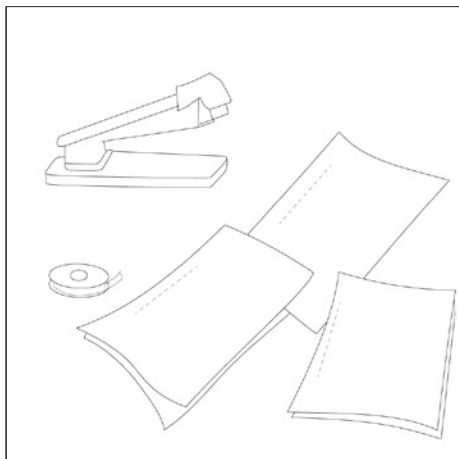
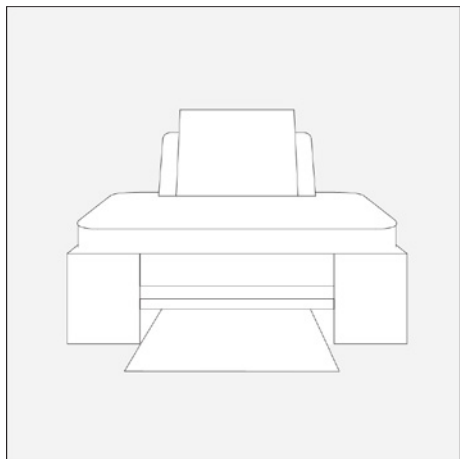

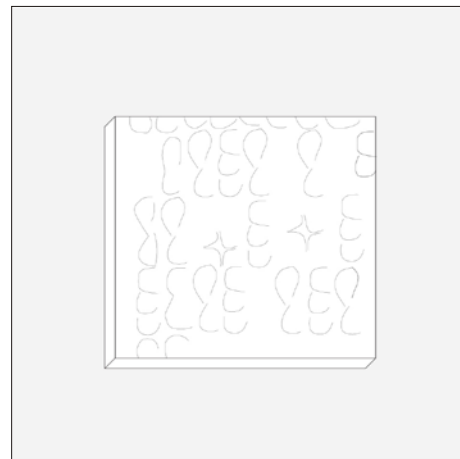
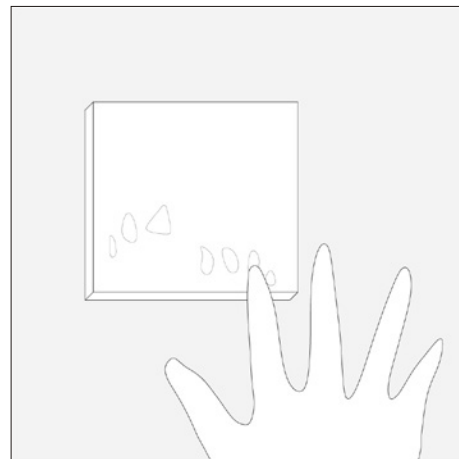
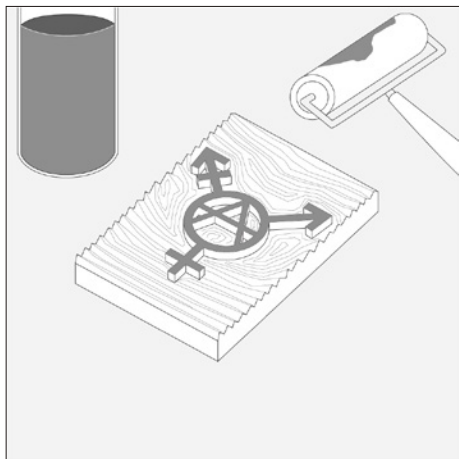
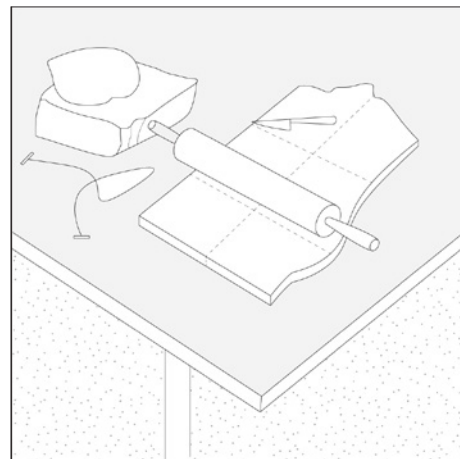
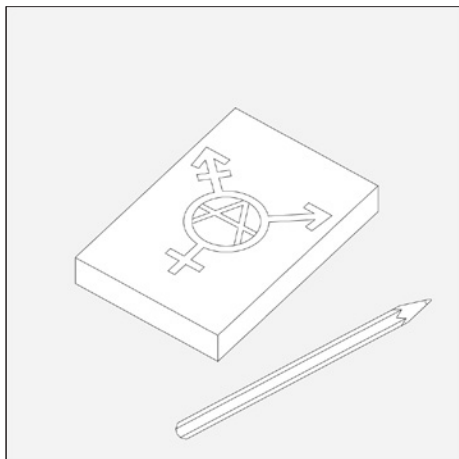

knot soil print

knot soil print

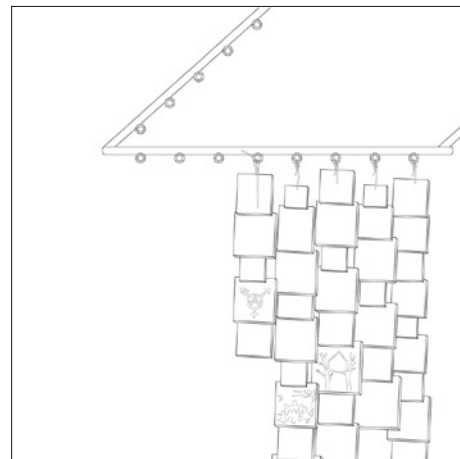
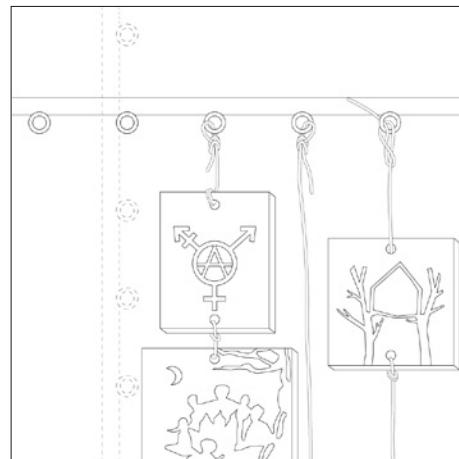
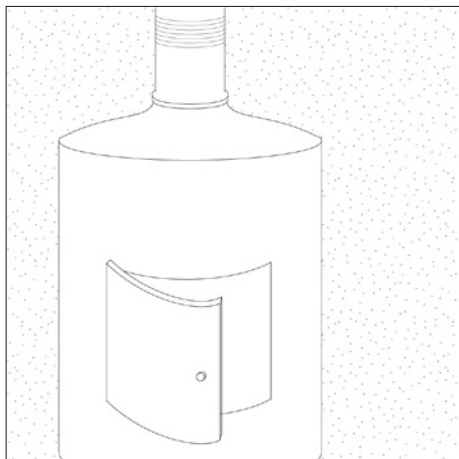
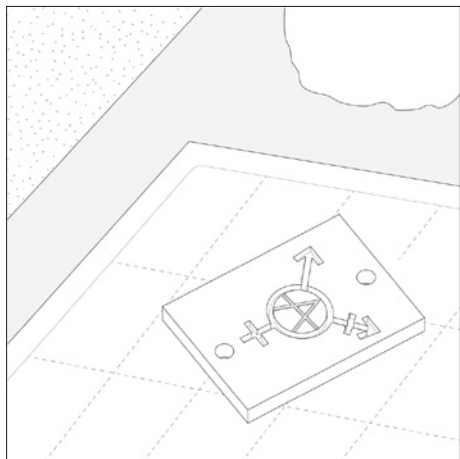
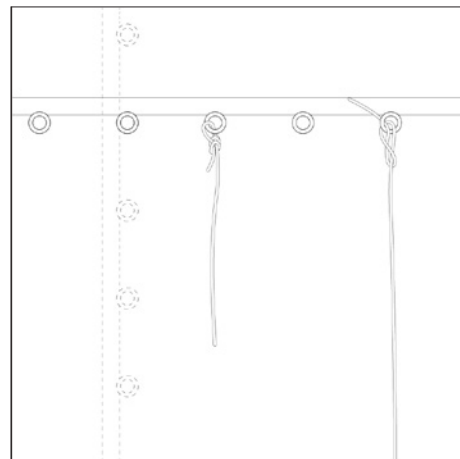
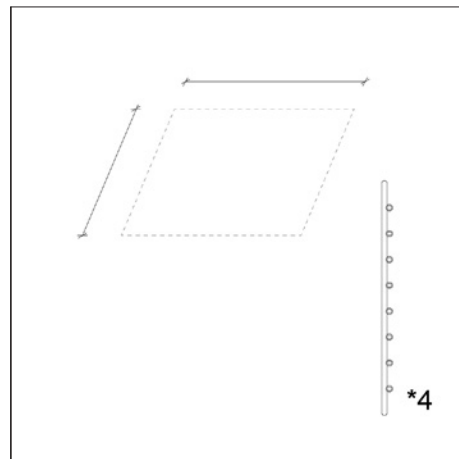
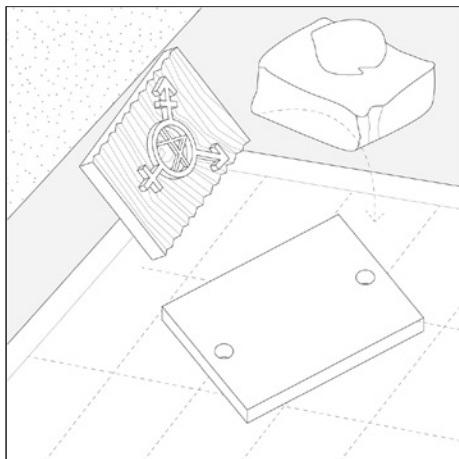
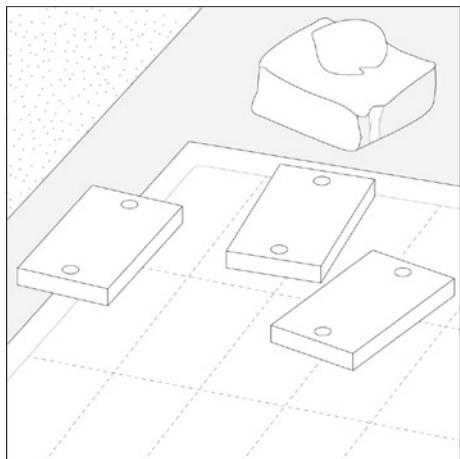

knot soil print

knot soil print

